

Eureka Math™

Grade K Module 2

Student File_A

Student Workbook

This file contains

- GK-M2 Problem Sets¹
- GK-M2 Homework
- GK-M2 Templates (including cut outs)²

¹Note that Lesson 10 of this module does not include Problem Set pages.

²Note that not all lessons in this module include templates or cut outs.

Published by the non-profit GREAT MINDS®.

Copyright © 2015 Great Minds. No part of this work may be reproduced, sold, or commercialized, in whole or in part, without written permission from Great Minds. Non-commercial use is licensed pursuant to a Creative Commons Attribution-NonCommercial-ShareAlike 4.0 license; for more information, go to <http://greatminds.net/maps/math/copyright>. “Great Minds” and “Eureka Math” are registered trademarks of Great Minds.

Printed in the U.S.A.

This book may be purchased from the publisher at eureka-math.org

10 9 8 7 6 5 4 3 2

GK-M2-SFA-1.3.1-06.2016

Name _____

Date _____

Sort the shapes.

Shapes with a Curve

Shapes without a Curve

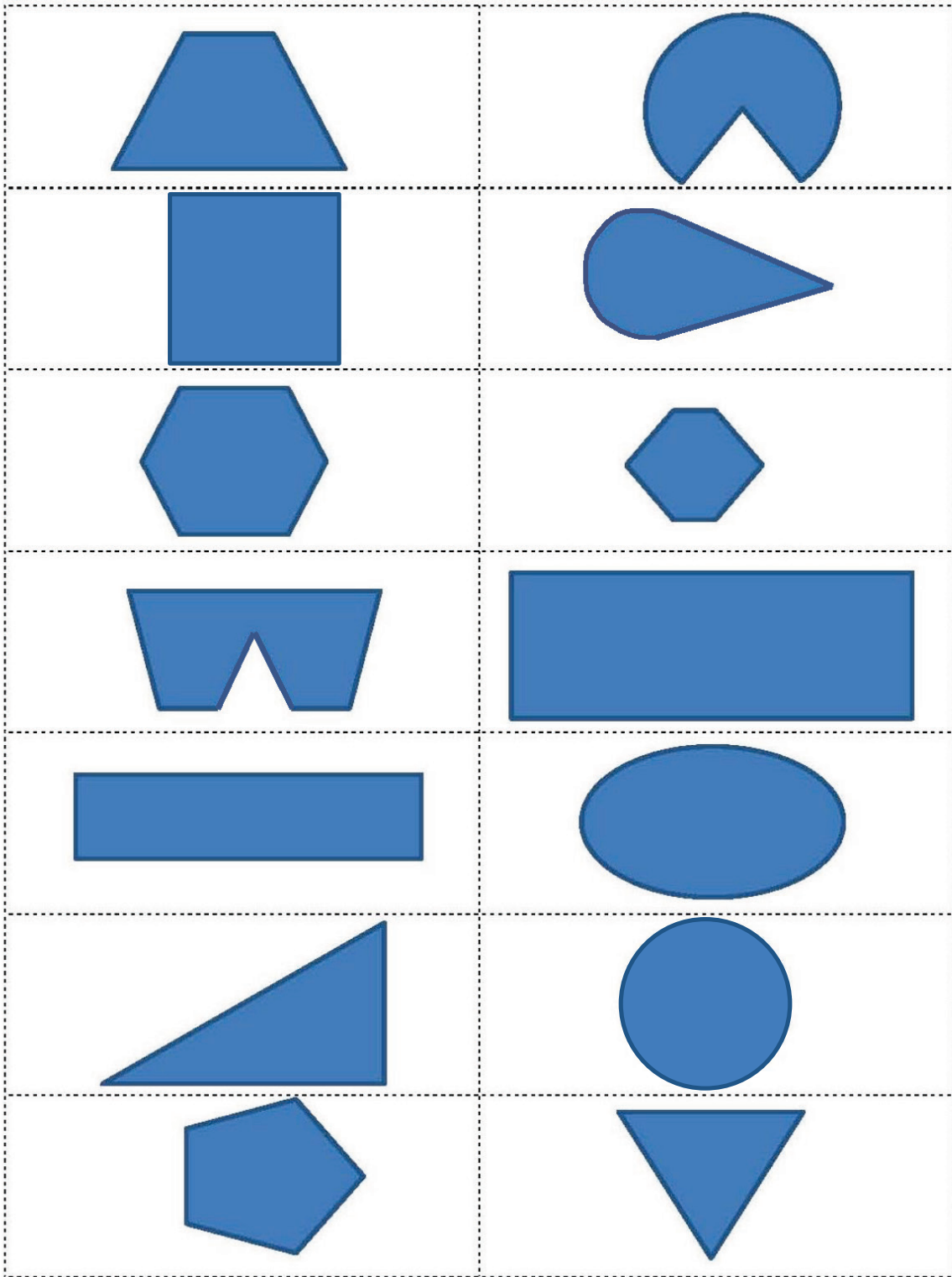

Name _____

Date _____

Draw a line from the shape to its matching object.

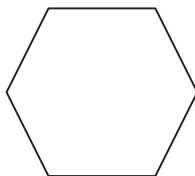
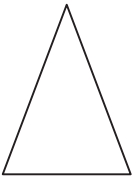
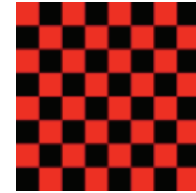
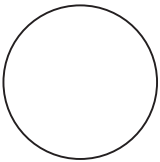

Name _____

Date _____

Find the triangles, and color them blue. Put an X on shapes that are not triangles.

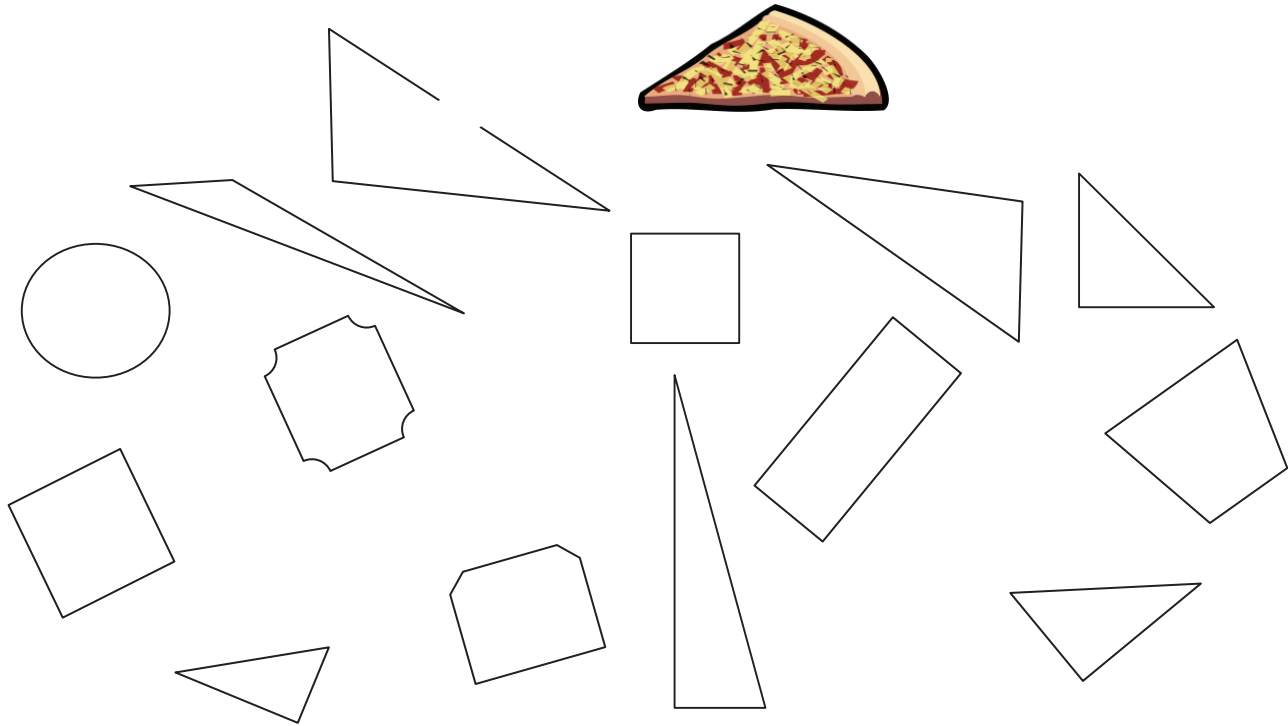

Draw some triangles.

Name _____

Date _____

Color the triangles red and the other shapes blue.

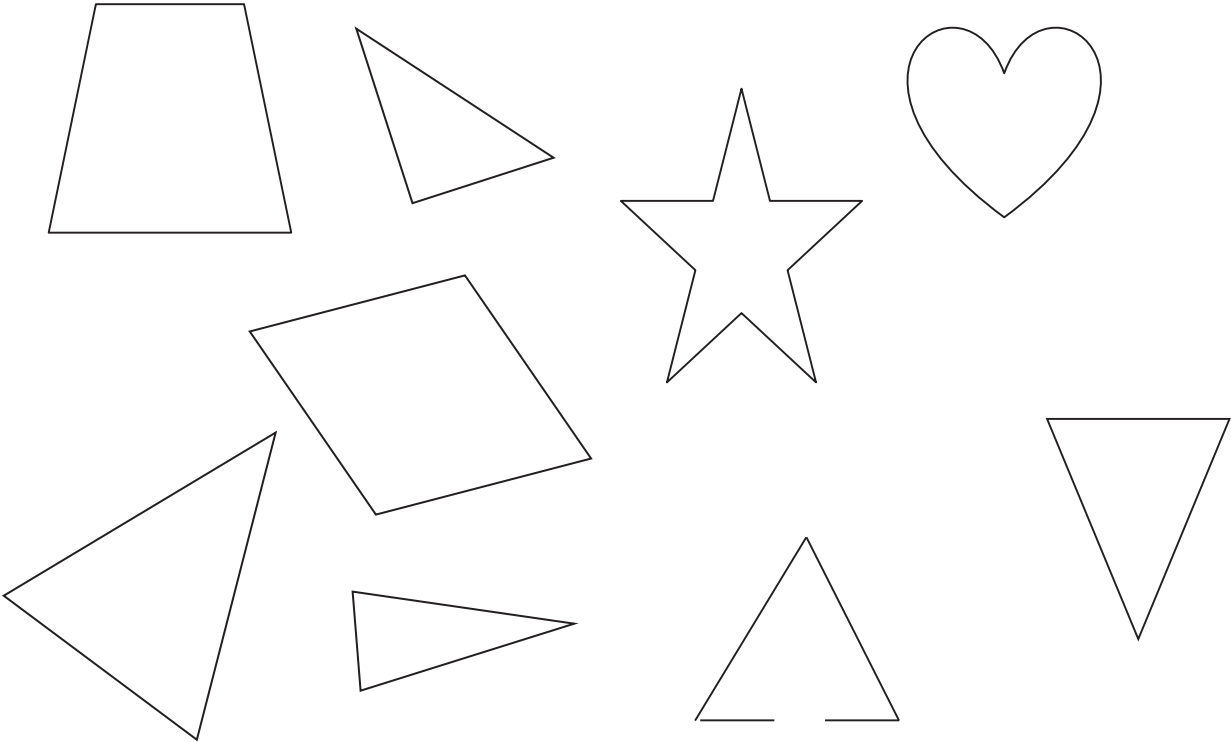

Draw 2 different triangles of your own.

Name _____

Date _____

Find the rectangles, and color them red. Put an X on shapes that are not rectangles.

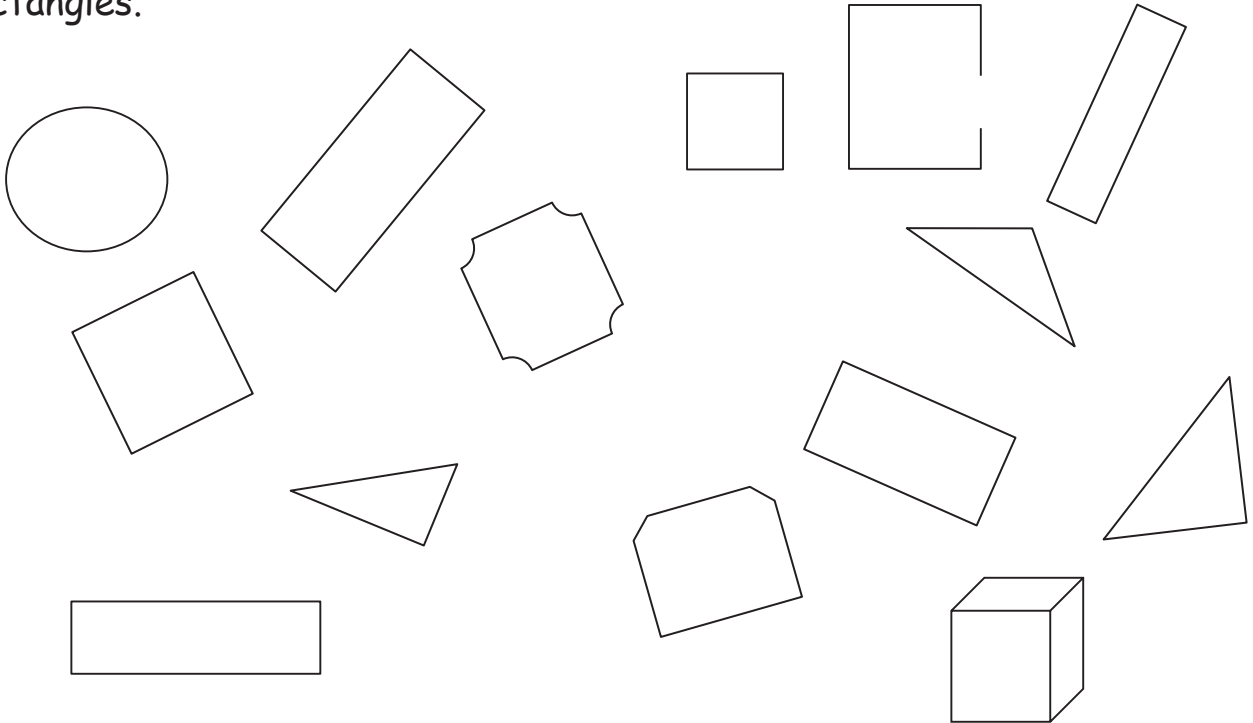

Draw some rectangles.

Name _____

Date _____

Color all the rectangles red. Color all the triangles green.

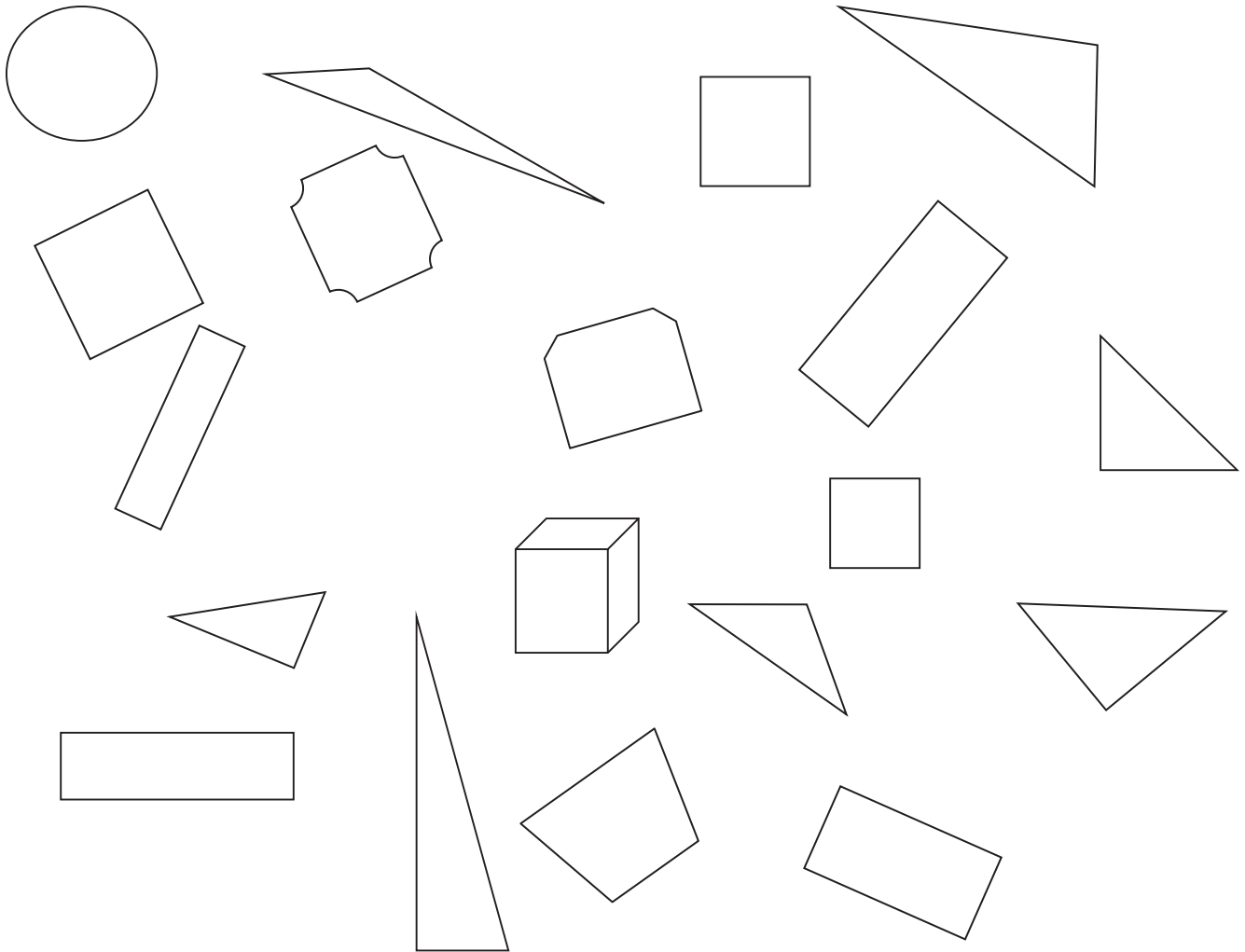

On the back of your paper, draw 2 rectangles and 3 triangles.
How many shapes did you draw? Put your answer in the circle.

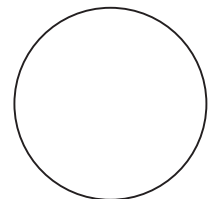

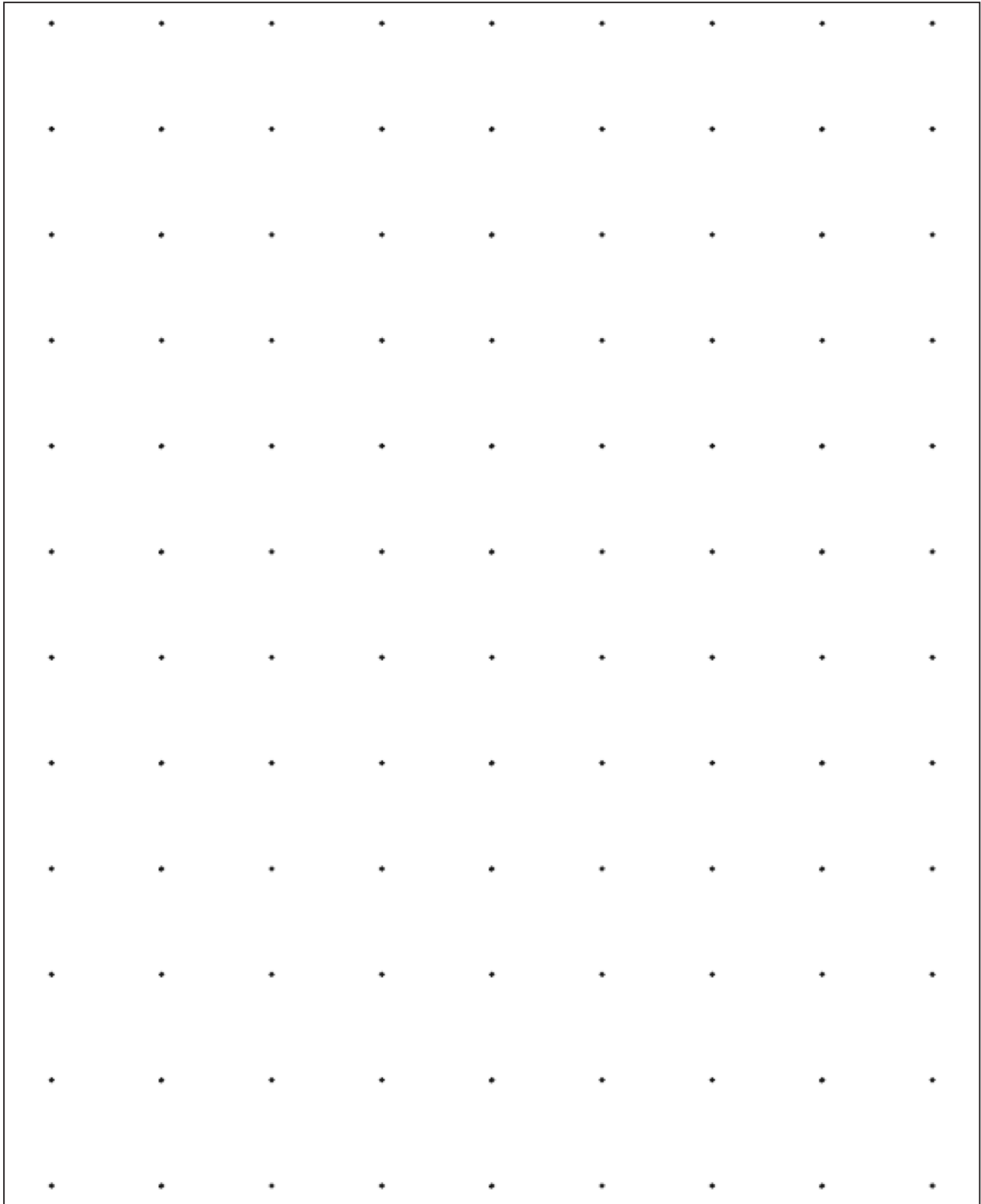

dot paper

Name _____

Date _____

Find the circles, and color them green. Find the hexagons, and color them yellow. Put an X on shapes that are not hexagons or circles.

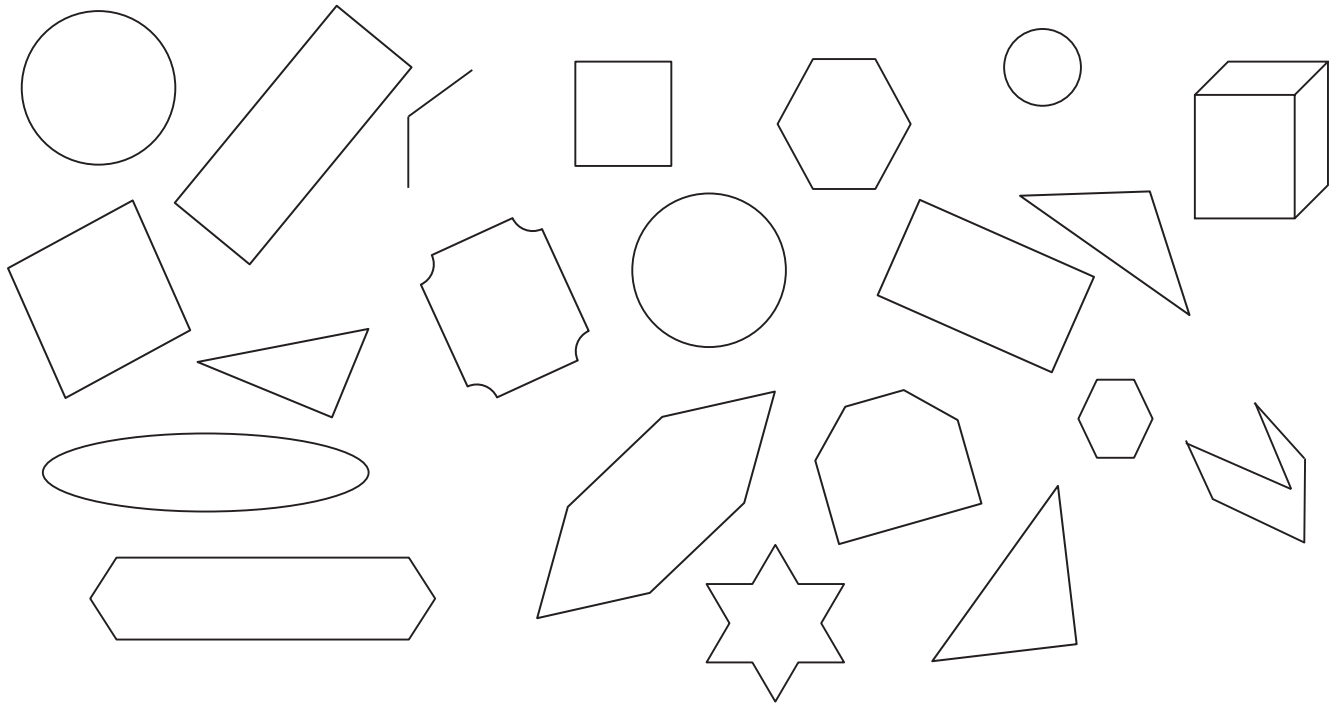

Draw hexagons and circles.

Name _____ Date _____

Color the triangles blue.

Color the rectangles red.

Color the circles green.

Color the hexagons yellow.

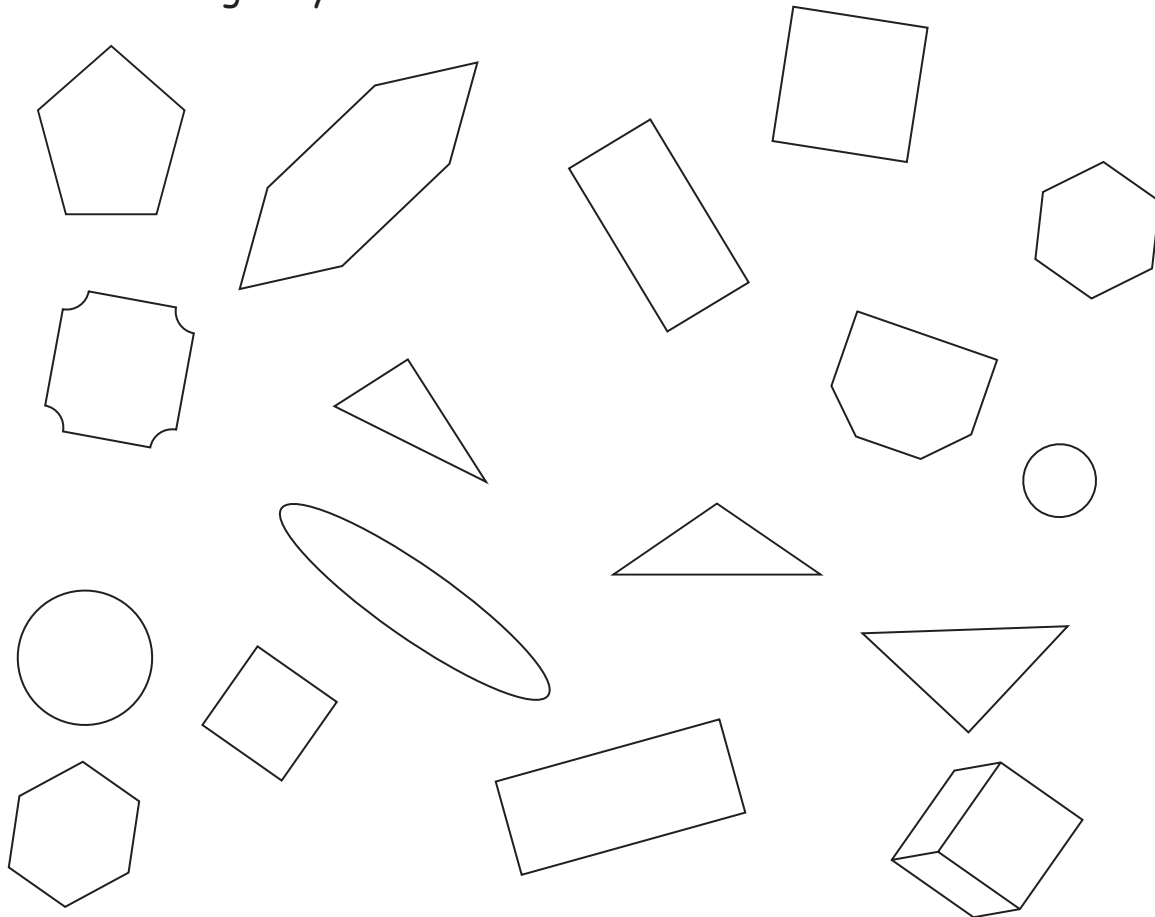

On the back of your paper, draw 2 triangles and 1 hexagon.

How many shapes did you draw? _____

Name _____

Date _____

Cut out all of the shapes, and put them next to your paper with the duck.
Listen to the directions, and glue the objects onto your paper.

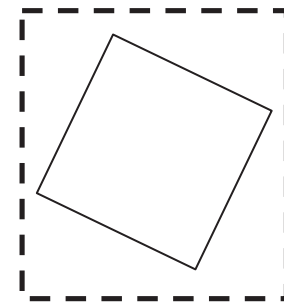
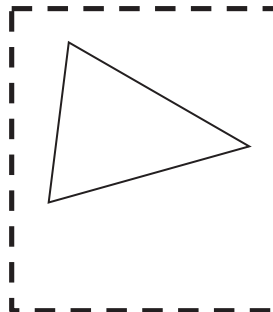
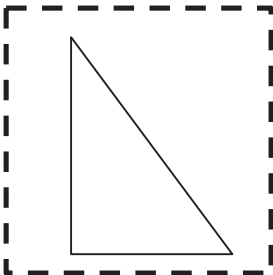
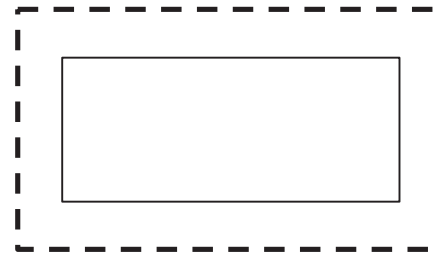
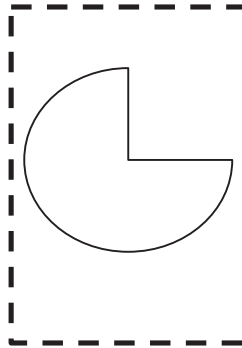
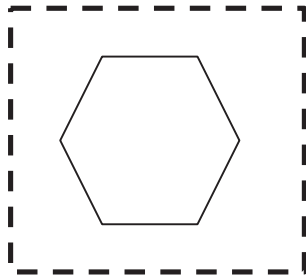
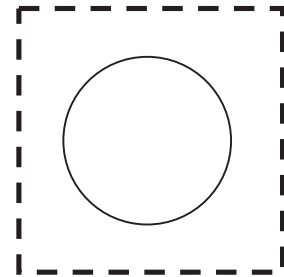
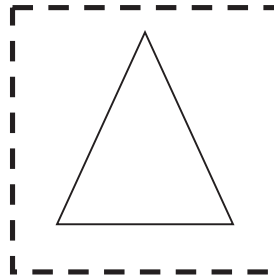
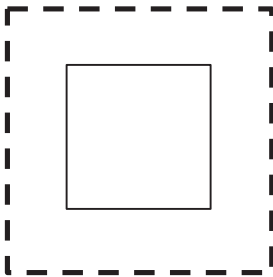

Name _____

Date _____



Name _____

Date _____

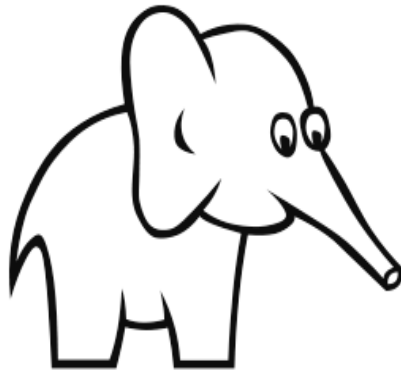

- **Behind** the elephant, draw a shape with 4 straight sides that are exactly the same length. Color it blue.
- **Above** the elephant, draw a shape with no corners. Color it yellow.
- **In front of** the elephant, draw a shape with 3 straight sides. Color it green.
- **Below** the elephant, draw a shape with 4 sides, 2 long and 2 short. Color it red.
- **Below** the elephant, draw a shape with 6 corners. Color it orange.

On the back of your paper, draw 1 hexagon and 4 triangles.
How many shapes did you draw? Put your answer in the circle.

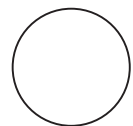

Name _____

Date _____

Match these objects and solids by drawing a line with your ruler from the object to the solid.

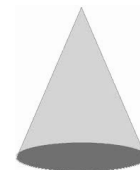
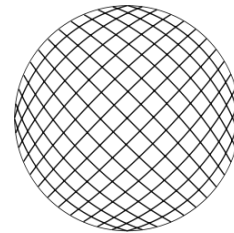
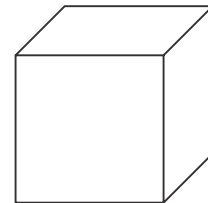
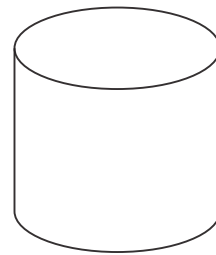

On the back of the paper, draw solid shapes that you see in the classroom.

Name _____

Date _____

Find things in your house or in a magazine that look like these solids. Draw the solids or cut out and paste pictures from a magazine.

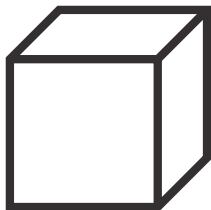
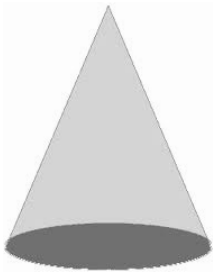
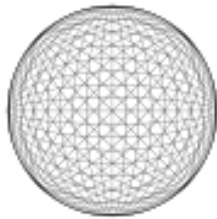
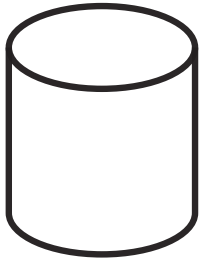

Name _____

Date _____

Circle the cylinders with red.

Circle the cubes with yellow.

Circle the cones with green.

Circle the spheres with blue.

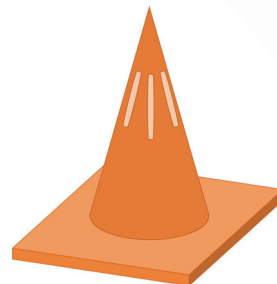
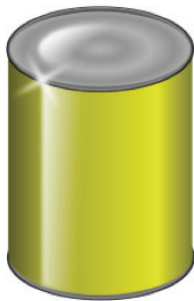
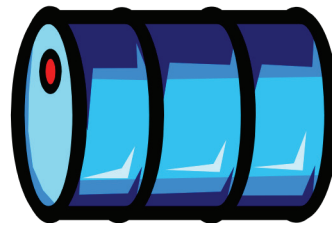
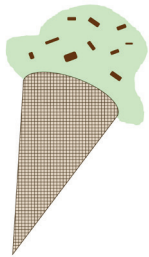

Name _____

Date _____

Cut one set of solid shapes. Sort the 4 solid shapes. Paste onto the chart.

These have corners.

These do not have corners.

--	--

Cut the other set of solid shapes, and make a rule for how you sorted them. Paste onto the chart.

--	--

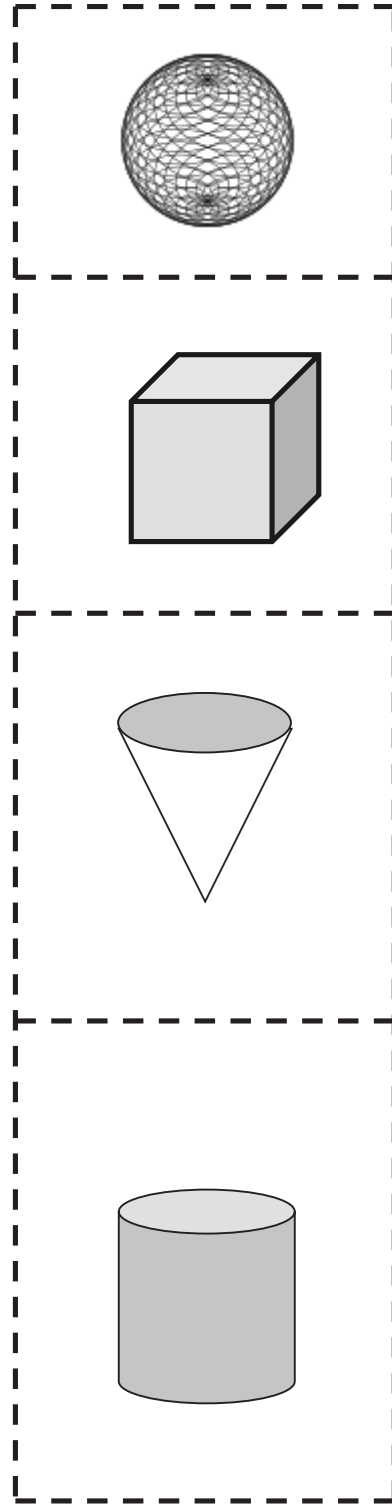
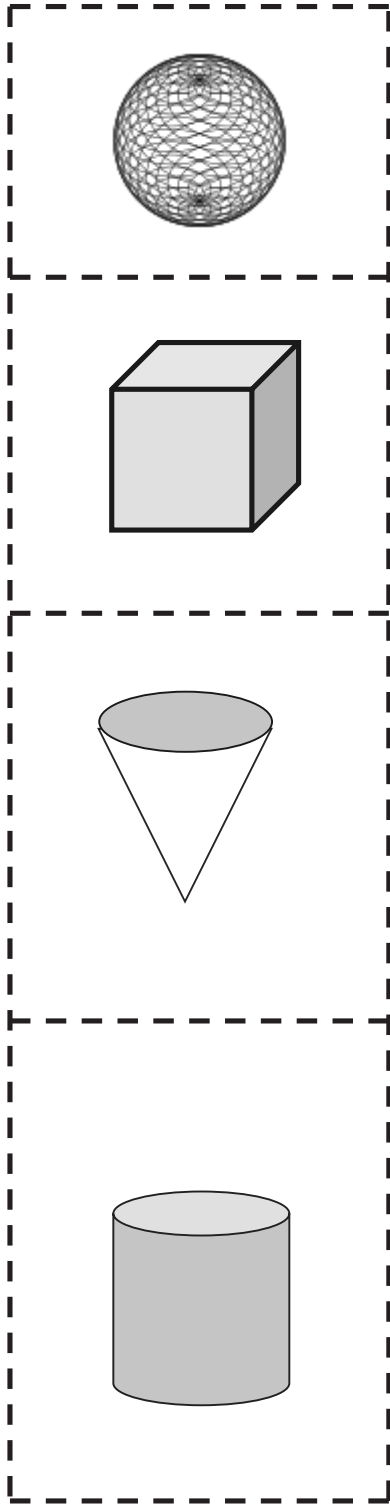

Name _____

Date _____



Name _____

Date _____

Tell someone at home the names of each solid shape.

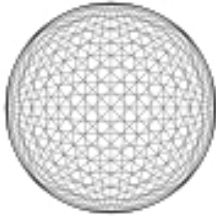

Sphere

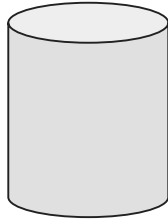

Cylinder

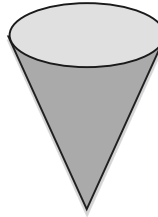

Cone

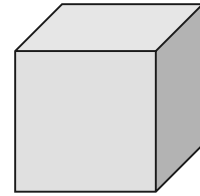

Cube



Color the car **beside** the stop sign green.

Circle the **next** car with blue.

Color the car **behind** the circled car red.

Draw a road **below** the cars.

Draw a policeman **in front of** the cars.

Draw a sun **above** the cars.

Name _____

Date _____

Circle the pictures of the flat shapes with red. Circle the pictures of the solid shapes with green.

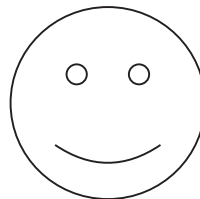
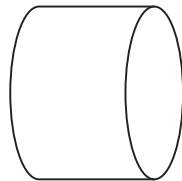
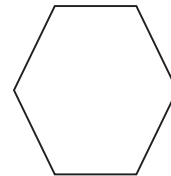
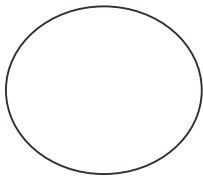
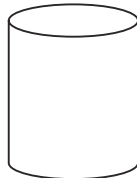
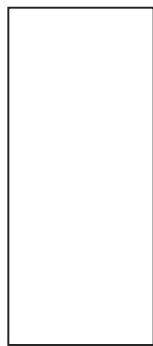
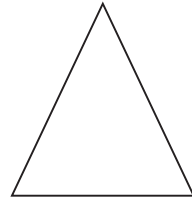
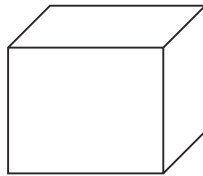
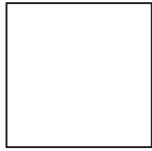
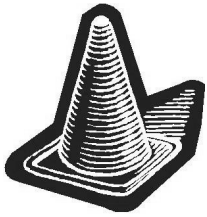

Name _____

Date _____

In each row, circle the one that doesn't belong. Explain your choice to a grown-up.

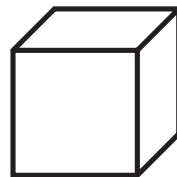
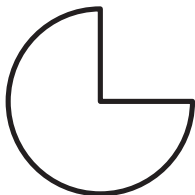
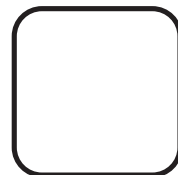
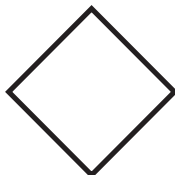
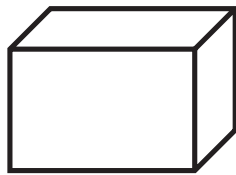
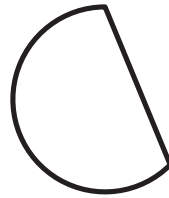
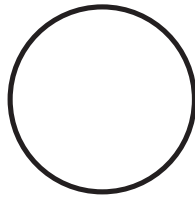
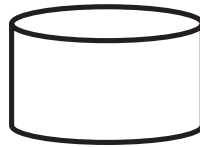
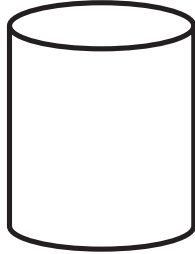
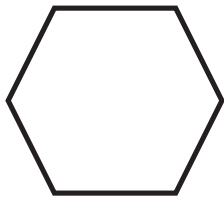
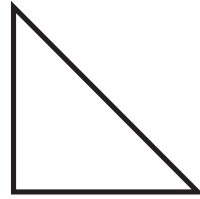
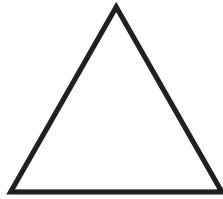
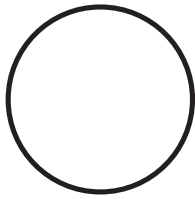

Name _____

Date _____

Shape Up Your Kitchen!

Search your kitchen to see what shapes and solids you can find. Make a kitchen-shaped collage by drawing the shapes that you see and by tracing the faces of the solids that you find. Color your collage.

Name _____

Date _____

These are (____).

These are not (____).

work mat

Cut Out Packet

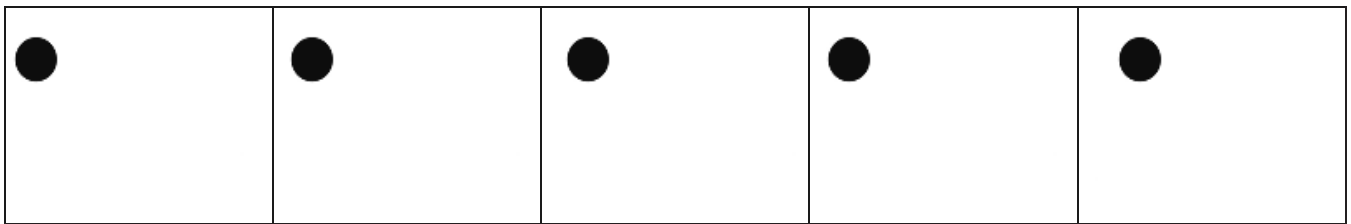
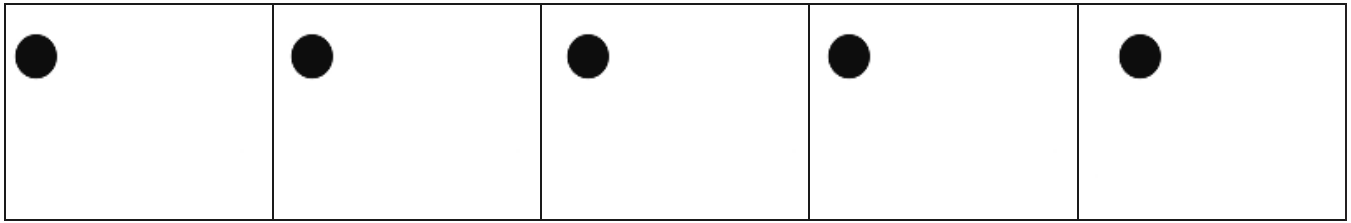
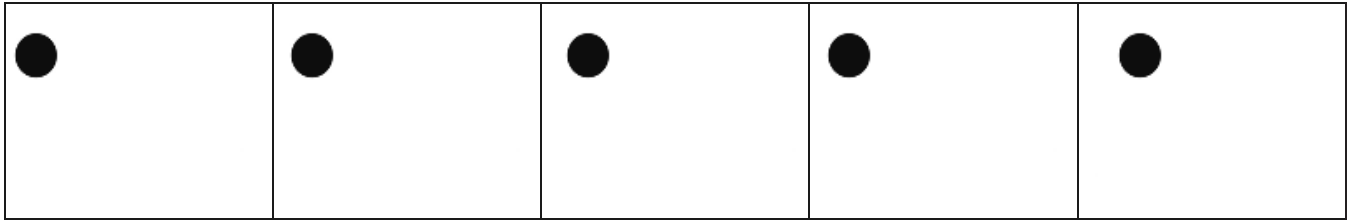
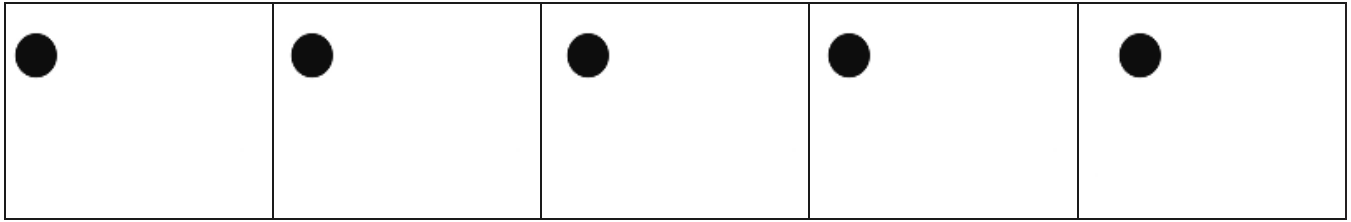
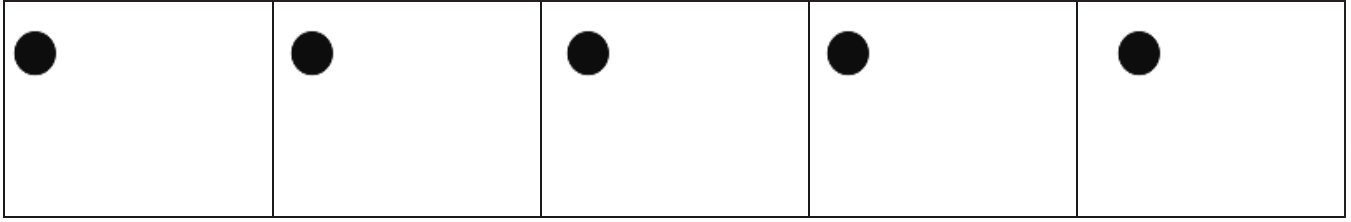

5-group mat

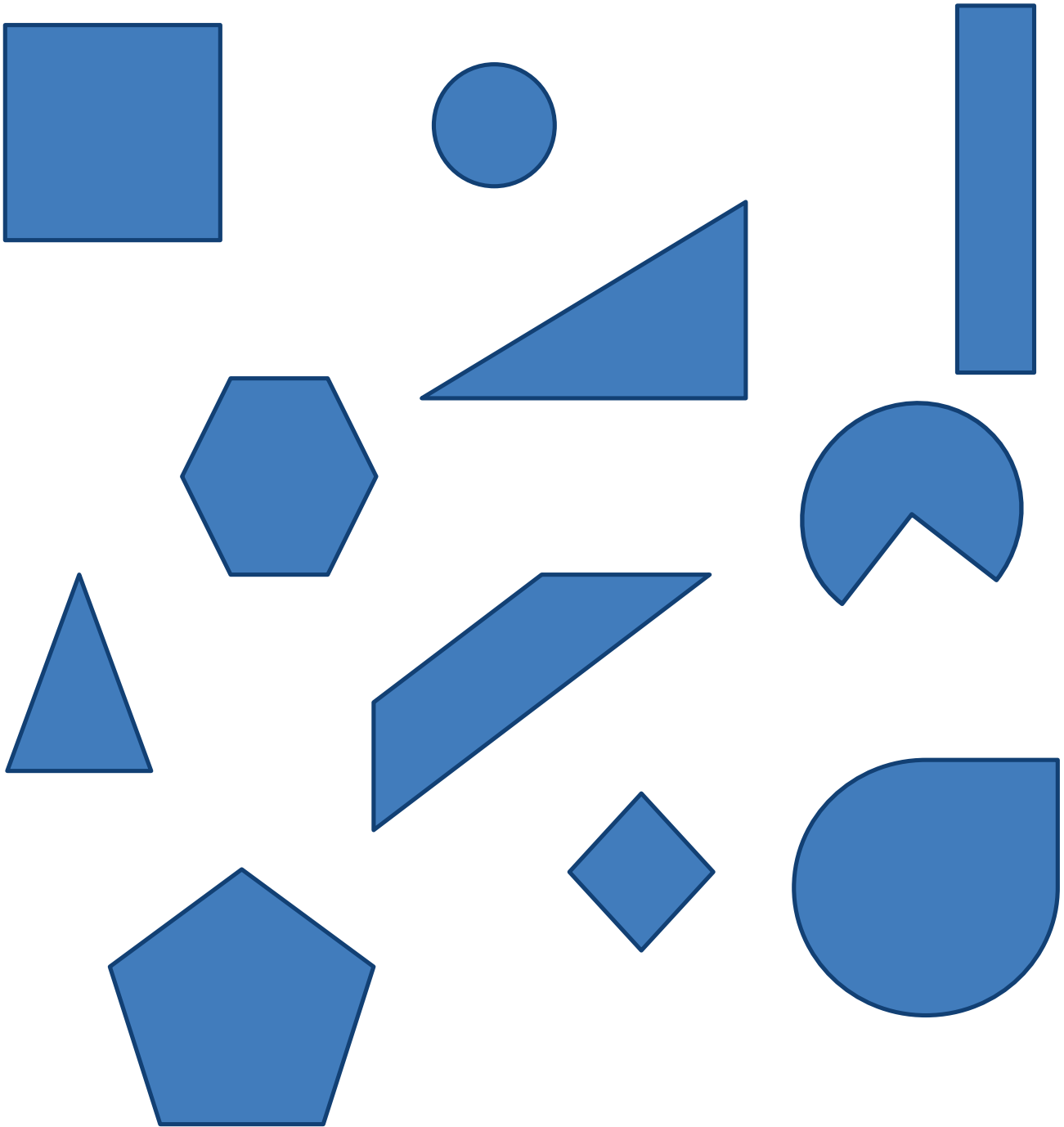

shapes

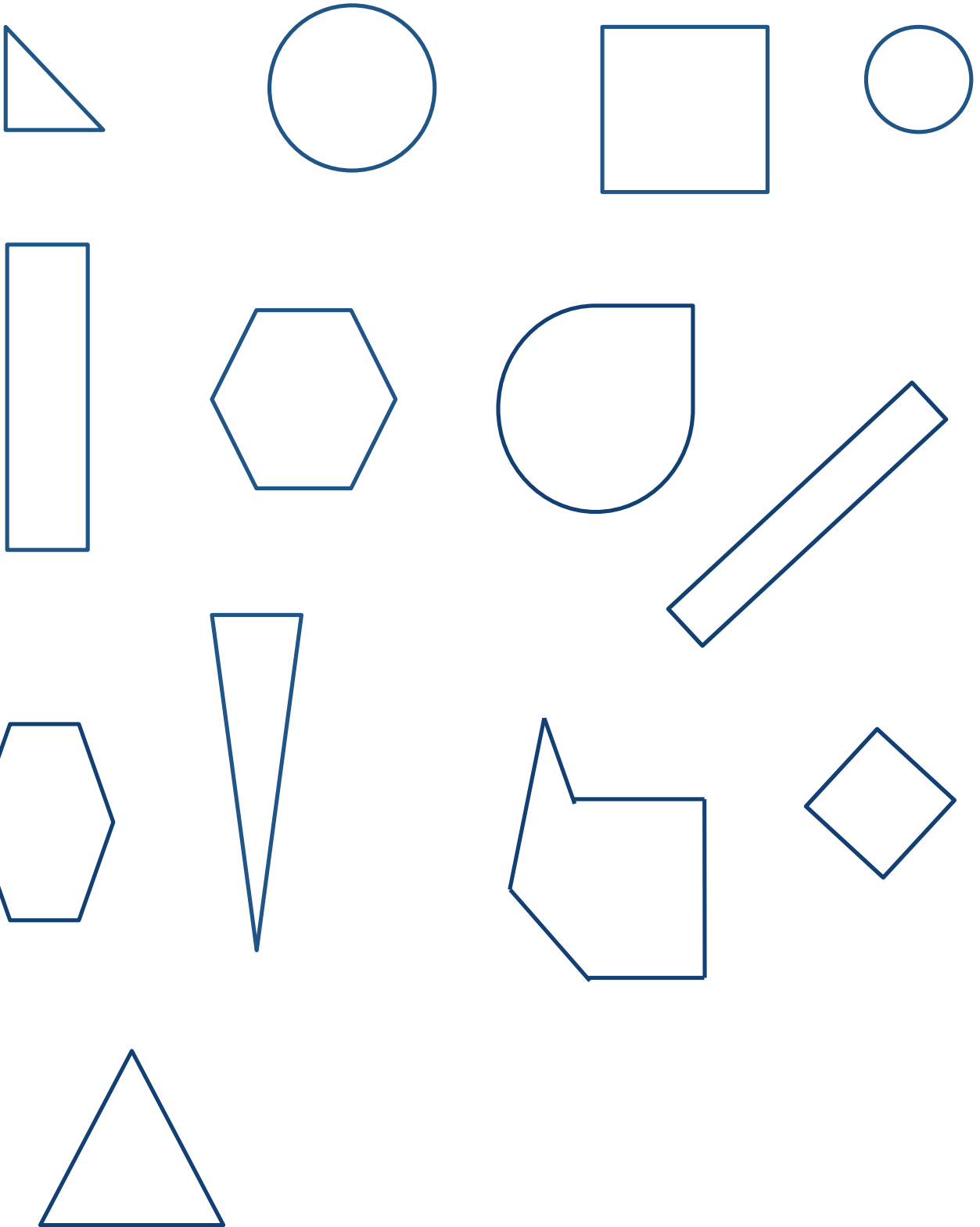

shapes

1	2	3	4	5	6	7	8	9	10
---	---	---	---	---	---	---	---	---	----

1	2	3	4	5	6	7	8	9	10
---	---	---	---	---	---	---	---	---	----

1	2	3	4	5	6	7	8	9	10
---	---	---	---	---	---	---	---	---	----

1	2	3	4	5	6	7	8	9	10
---	---	---	---	---	---	---	---	---	----

number path

Directions: Read to students.

Paste the sphere **above** the train.

Paste the cube **behind** the train.

Paste the cylinder **in front of** the train.

Paste the cone **below** the train.

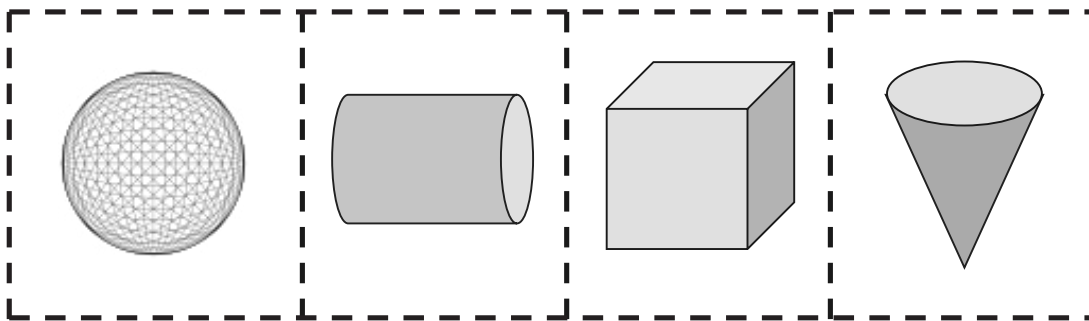

Provide one strip for every student.

