

Eureka Math Module 6 - Geometry

Lesson 1 - Complementary and Supplementary Angles

Essential Questions:

Term	Definition
	Two angles $\angle AOC$ and $\angle COB$, with a common side \overline{OC} , are _____ angles if C is in the interior of $\angle AOB$.
	When two lines intersect, any two non-adjacent angles formed by those lines are called _____ angles, or _____ angles.
	Two lines are _____ if they intersect in one point, and any of the angles formed by the intersection of the lines is 90° . Two segments or rays are _____ if the lines containing them are lines.

Complete the missing information in the table below. In the 'Statement' column, use the illustration to write an equation that demonstrates the angle relationship; use all forms of angle notation in your equations.

Angle Relationship	Abbreviation	Statement	Illustration
Adjacent Angles		The measurements of adjacent angles add.	
Vertical Angles		Vertical angles have equal measures.	

Eureka Math Module 6 - Geometry

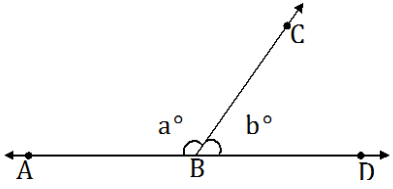
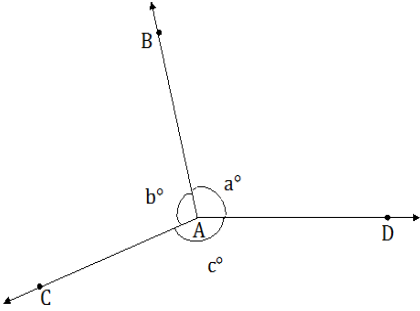
<p>Angles on a Line</p>		<p>If the vertex of a ray lies on a line but the ray is not contained in that line, then the sum of measurements of the two angles formed is 180°.</p>	
<p>Angles at a Point</p>		<p>Suppose three or more rays with the same vertex separate the plane into angles with disjoint interiors. Then the sum of all the measurements of the angles is 360°.</p>	

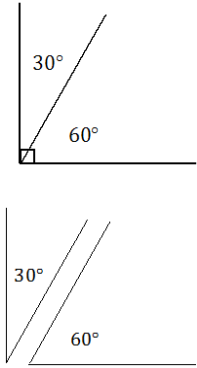
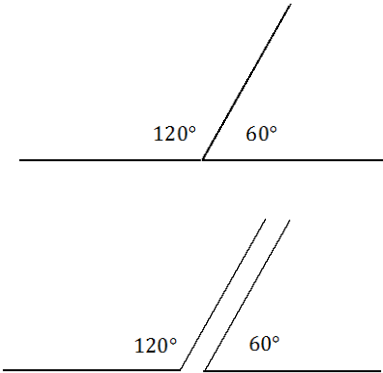
Angle Relationship	Definition	Diagram
<p>Complementary Angles</p>		
<p>Supplementary Angles</p>		

Eureka Math Module 6 - Geometry

Exercise 1

In a complete sentence, describe the relevant angle relationships in the diagram. Write an equation for the angle relationship shown in the figure and solve for x . Confirm your answers by measuring the angle with a protractor.

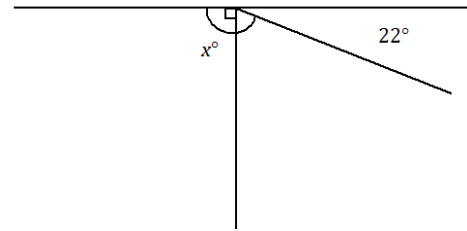

Example 1

The measures of two supplementary angles are in the ratio of 2:3. Find the two angles.

Exercises 2-4

2. In a pair of complementary angles, the measurement of the larger angle is three times that of the smaller angle. Find the measurements of the two angles.

3. The measure of a supplement of an angle is 6° more than twice the measure of the angle. Find the two angles.

4. The measure of a complement of an angle is 32° more than three times the angle. Find the two angles.

Eureka Math Module 6 - Geometry

Example 2

Two lines meet at a point that is also the vertex of an angle. Set up and solve an appropriate equation for x and y .

Eureka Math Module 6 - Geometry



Lesson 1 - Independent Practice

1. Two lines meet at the common vertex of two rays. Set up and solve the appropriate equations to determine x and y .

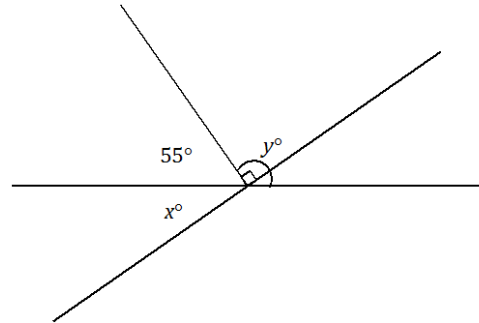

2. Two lines meet at the common vertex of two rays. Set up and solve the appropriate equations to determine x and y .

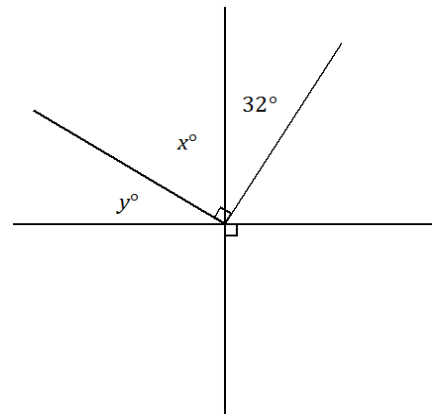

3. Two lines meet at the common vertex of two rays. Set up and solve an appropriate equation for x and y .

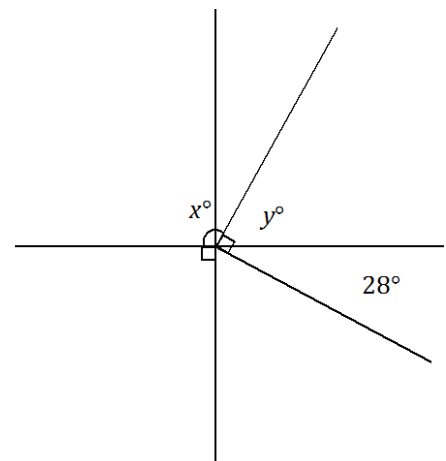

Eureka Math Module 6 - Geometry

4. Set up and solve the appropriate equations for s and t .

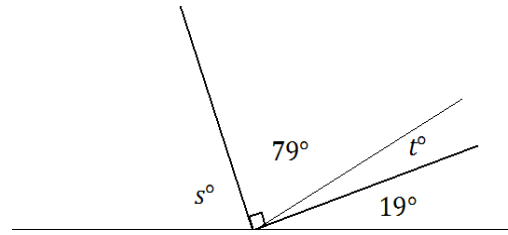

5. Two lines meet at the common vertex of two rays. Set up and solve the appropriate equations for m and n .

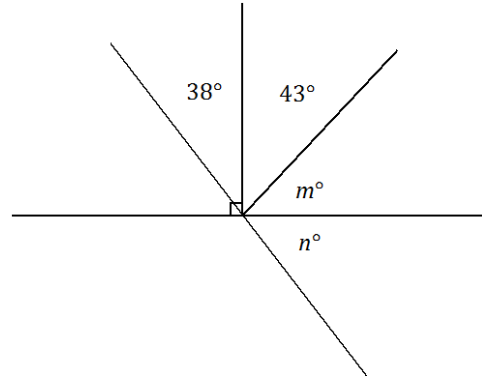

6. The supplement of the measurement of an angle is 16° less than three times the angle. Find the angle and its supplement.
7. The measurement of the complement of an angle exceeds the measure of the angle by 25%. Find the angle and its complement.

Lesson 2 - Solving for Unknown Angles Using Equations

Essential Questions:

Classwork

Opening Exercise

Two lines meet at a point. In a complete sentence, describe the relevant angle relationships in the diagram. Find the values of r , s , and t .

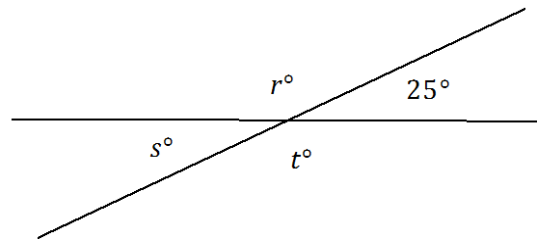

Example 1

Two lines meet at the vertex of a ray. In a complete sentence, describe the relevant angle relationships in the diagram. Set up and solve an equation to find the value of p and r .

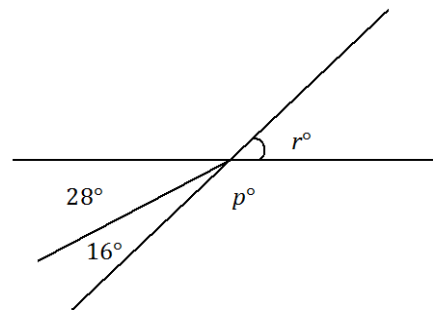

Eureka Math Module 6 - Geometry

Exercise 1

Three lines meet at a point. In a complete sentence, describe the relevant angle relationship in the diagram. Set up and solve an equation to find the value of a .

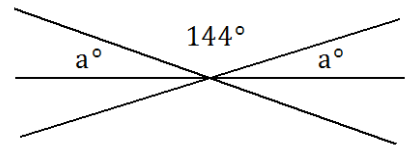

Example 2

Three lines meet at a point. In a complete sentence, describe the relevant angle relationships in the diagram. Set up and solve an equation to find the value of z .

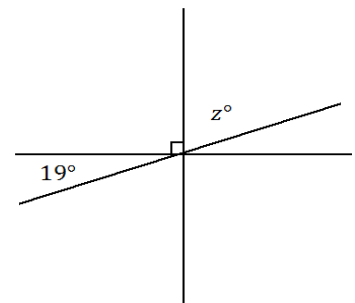

Eureka Math Module 6 - Geometry

Exercise 2

Three lines meet at a point; $\angle AOF = 144^\circ$. In a complete sentence, describe the relevant angle relationships in the diagram. Set up and solve an equation to determine the value of c .

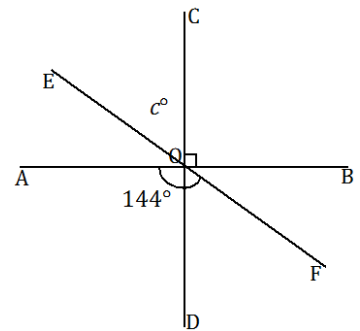

Example 3

Two lines meet at the vertex of a ray. The ray is perpendicular to one of the lines as shown. In a complete sentence, describe the relevant angle relationships in the diagram. Set up and solve an equation to find the value of t .

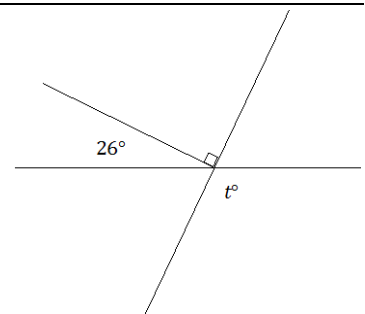

Eureka Math Module 6 - Geometry

Exercise 3

Two lines meet at the vertex of a ray. The ray is perpendicular to one of the lines as shown. In a complete sentence, describe the relevant angle relationships in the diagram. You may add labels to the diagram to help with your description of the angle relationship. Set up and solve an equation to find the value of v .

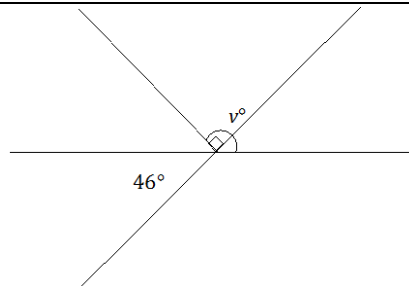

Example 4

Three lines meet at a point. In a complete sentence, describe the relevant angle relationships in the diagram. Set up and solve an equation to find the value of x . Is your answer reasonable?

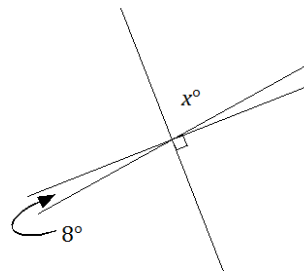

Eureka Math Module 6 - Geometry

Exercise 4 - 5

4. Two lines meet at the common vertex of two rays. In a complete sentence, describe the relevant angle relationships in the diagram. Set up and solve an equation to find the value of x . Find the measurements of $\angle AOB$ and $\angle BOC$.

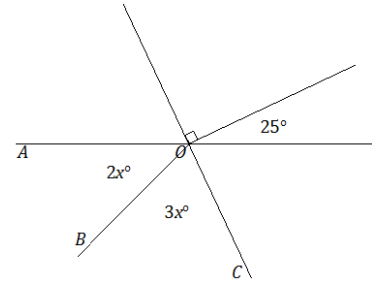

5a. In a complete sentence, describe the relevant angle relationships in the diagram. Set up and solve an equation to find the value of x . Find the measurements of $\angle AOB$ and $\angle BOC$.

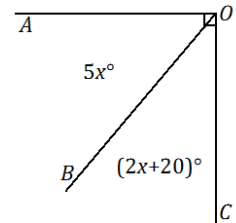

5b. Katrina was solving the problem above and wrote the equation $7x + 20 = 90$.
Then she rewrote this as $7x + 20 = 70 + 20$.
Why did she rewrite the equation in this way? How does this help her to find the value of x ?

Summary

Eureka Math Module 6 - Geometry



Lesson 2 - Independent Practice

1. Two lines meet at the vertex of a ray. Set up and solve an equation to find the value of c .

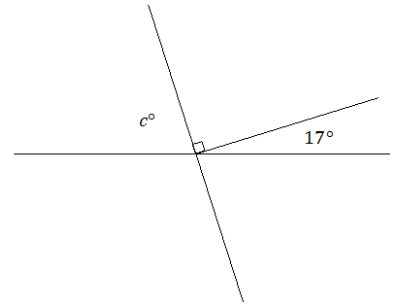

2. Two lines meet at the vertex of a ray. Set up and solve an equation to find the value of a . Explain why your answer is reasonable.

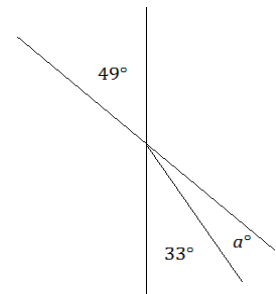

3. Two lines meet at the vertex of a ray. Set up and solve an equation to find the value of w .

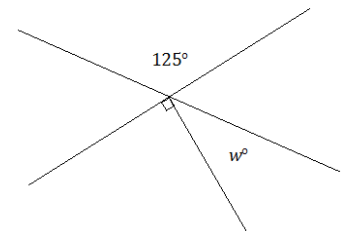

4. Two lines meet at the common vertex of two rays. Set up and solve an equation to find the value of m .

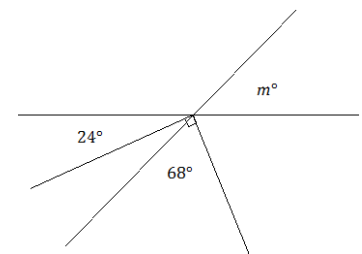

5. Three lines meet at a point. Set up and solve an equation to find the value of r .

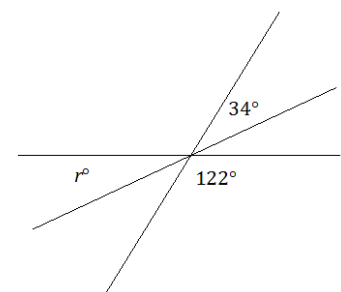

Eureka Math Module 6 - Geometry

6. Three lines meet at the vertex of a ray. Set up and solve an equation to find the value of each variable in the diagram.

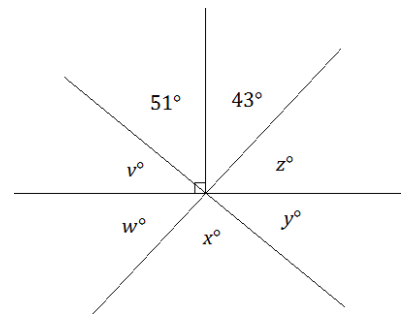

7. Set up and solve an equation to find the value of x . Find the measurement of $\angle AOB$ and of $\angle BOC$.

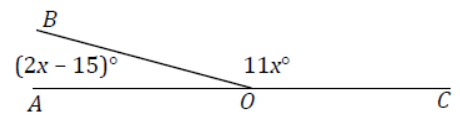

8. Set up and solve an equation to find the value of x . Find the measurement of $\angle AOB$ and of $\angle BOC$.

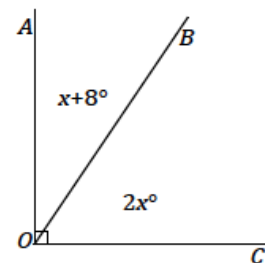

Eureka Math Module 6 - Geometry

9. Set up and solve an equation to find the value of x . Find the measurement of $\angle AOB$ and of $\angle BOC$.

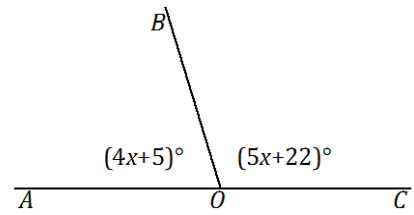

10. Write a verbal problem that models the following diagram. Then solve for the two angles.

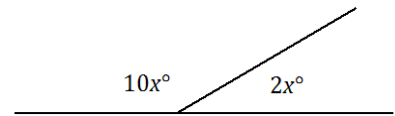

Lesson 3 - Solving for Unknown Angles Using Equations

Essential Questions:

Classwork

Opening Exercise

Two lines meet at the common vertex of two rays; the measurement of $\angle COF = 134^\circ$. Set up and solve an equation to find the value of x and y .

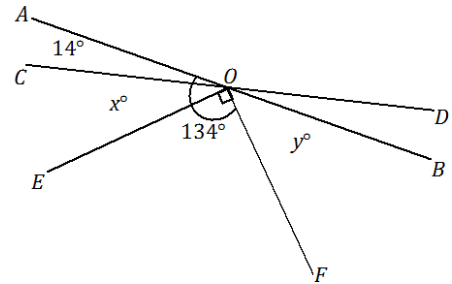

Example 1

Set up and solve an equation to find the value of x .

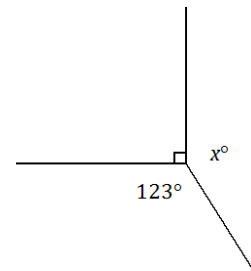

Exercise 1

Five rays meet at a common vertex. In a complete sentence, describe the relevant angle relationships in the diagram. Set up and solve an equation to find the value of a .

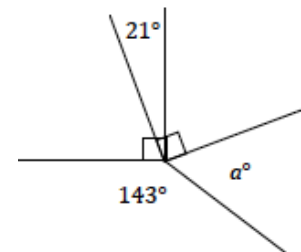

Eureka Math Module 6 - Geometry

Example 2

Four rays meet at a common vertex. In a complete sentence, describe the relevant angle relationships in the diagram. Set up and solve an equation to find the value of x . Find the measurements of angles $\angle BAC$ and $\angle DAE$.

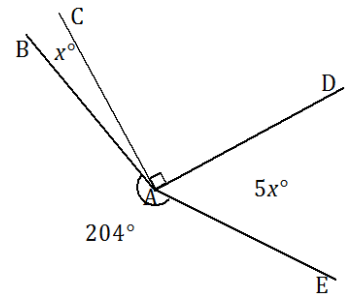

Exercise 2

Four rays meet at a common vertex. In a complete sentence, describe the relevant angle relationships in the diagram. Set up and solve an equation to find the value of x . Find the measurement of $\angle CAD$.

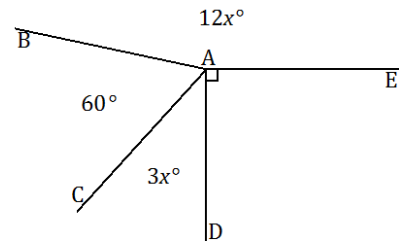

Eureka Math Module 6 - Geometry

Example 3

Two lines meet at the common vertex of two rays. In a complete sentence, describe the relevant angle relationships in the diagram. Set up and solve an equation to find the value of x . Find the measurements of angles $\angle BAC$ and $\angle BAH$.

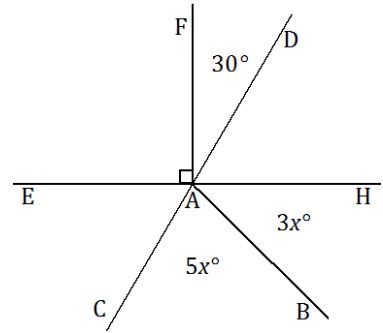

Exercise 3

Two lines meet at the common vertex of two rays. In a complete sentence, describe the relevant angle relationships in the diagram. Set up and solve an equation to find the value of x . Find the measurements of angles $\angle DHF$ and $\angle AHD$.

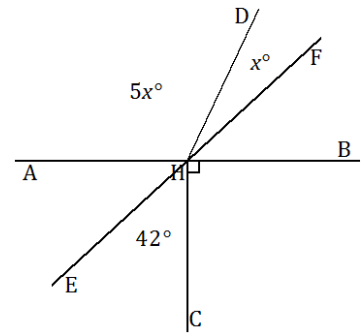

Eureka Math Module 6 - Geometry

Example 4

Two lines meet at a point. Set up and solve an equation to find the value of x . Find the measurement of one of the vertical angles.

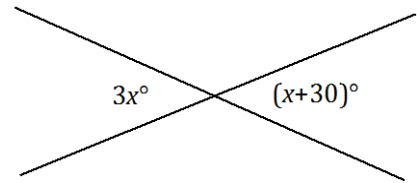

Exercise 4

Set up and solve an equation to find the value of x . Find the measurement of one of the vertical angles.

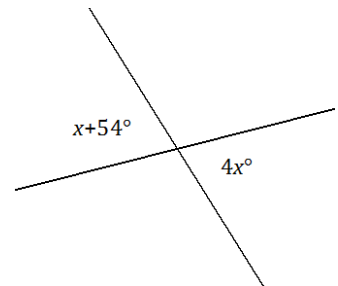

Summary

Eureka Math Module 6 - Geometry



Lesson 3 - Independent Practice

1. Two lines meet at a point. Set up and solve an equation to find the value of x .

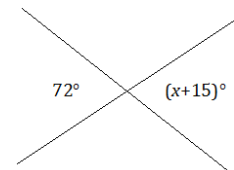

2. Three lines meet at a point. Set up and solve an equation to find the value of a . Is your answer reasonable? Explain how you know.

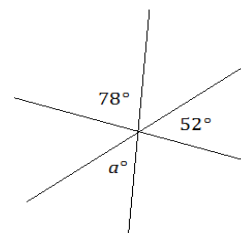

3. Two lines meet at the common vertex of two rays. Set up and solve an equation to find the values of a and b .

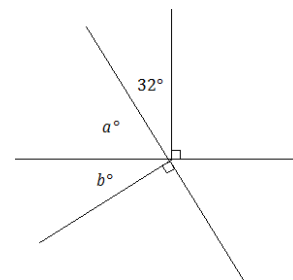

4. Two lines meet at the common vertex of two rays. Set up and solve an equation to find the values of x and y .

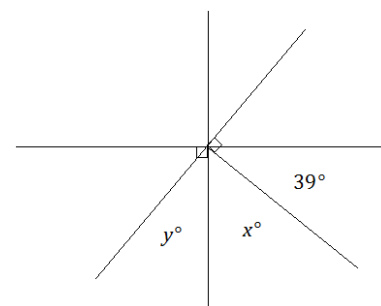

Eureka Math Module 6 - Geometry

5. Two lines meet at a point. Find the measurement of a vertical angle. Is your answer reasonable? Explain how you know.

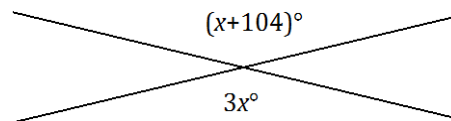

6. Three lines meet at the vertex of a ray. Set up and solve an equation to find the value of y .

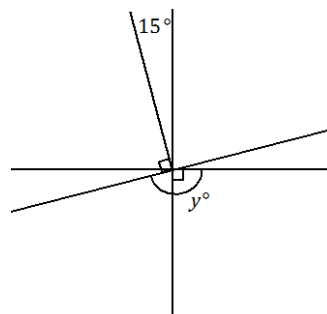

7. Three angles are at a point. The second angle is 20° more than the first, and the third angle is 20° more than the second angle.
- Find the measurement of all three angles.
 - Compare the expressions you used for the three angles and their combined expression. Explain how they are equal and how they reveal different information about this situation.

Eureka Math Module 6 - Geometry

8. Four adjacent angles are on a line. The measurements of the four angles are four consecutive even numbers. Determine the measurements of all four angles.

9. Three angles are at a point. The ratio of the measurement of the second angle to the measurement of the first angle is 4:3. The ratio of the measurement of the third angle to the measurement of the second angle is 5:4. Determine the measurements of all three angles.

10. Solve for x and y in the following diagram.

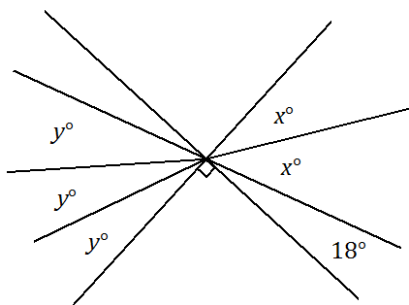

Lesson 4 - Solving for Unknown Angles Using Equations

Essential Questions:

Classwork

Opening Exercise

Four times the measurement of an angle is the complement of the angle. Find the measurement of the angle and its complement.

Example 1

Find the measurement of $\angle FAE$ and $\angle CAD$.

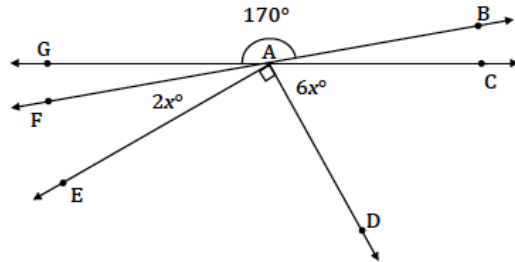

Two lines meet at a point. List the relevant angle relationship in the diagram. Set up and solve an equation to find the value of x . Find the measurement of one of the vertical angles.

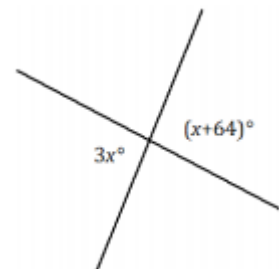

Eureka Math Module 6 - Geometry

Exercise 1

Set up and solve an equation to find the value of x . List the relevant angle relationship in the diagram. Find the measurement of one of the vertical angles.

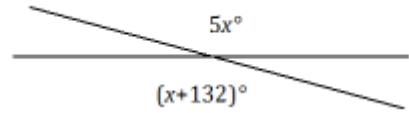

Example 2

Three lines meet at a point. List the relevant angle relationships in the diagram. Set up and solve an equation to find the value of b .

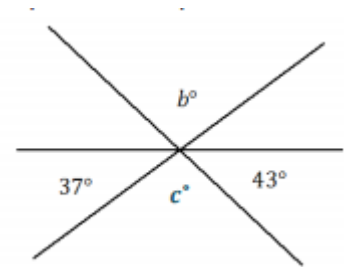

Exercise 2

Two lines meet at the common vertex of two rays. List the relevant angle relationships in the diagram. Set up and solve an equation to find the value of b .

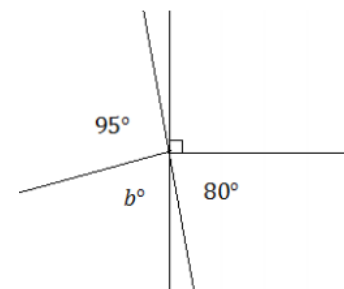

Eureka Math Module 6 - Geometry

Example 3

The measurement of an angle is $\frac{2}{3}$ the measurement of its supplement. Find the measurement of the angle.

Exercise 3

The measurement of an angle is $\frac{1}{4}$ the measurement of its complement. Find the measurement of the angle.

Eureka Math Module 6 - Geometry

Example 4

Three lines meet at the common vertex of a ray. List the relevant angle relationships in the diagram. Set up and solve an equation to find the value of z .

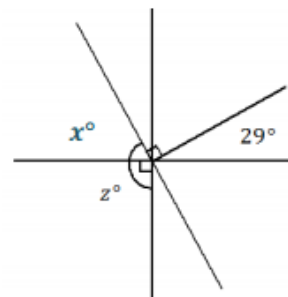

Exercise 4

Two lines meet at the common vertex of two rays. Set up and solve an equation to find the value of x . Find the measurement of $\angle GAF$ and of $\angle BAC$.

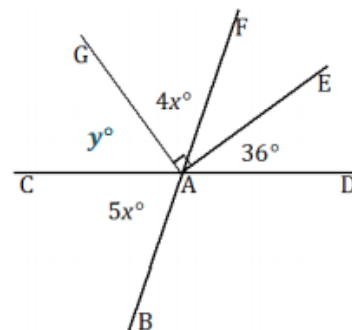

Summary

Eureka Math Module 6 - Geometry



Lesson 4 - Independent Practice

1. Four rays have a common vertex on a line. Set up and solve an equation to find the value of c .

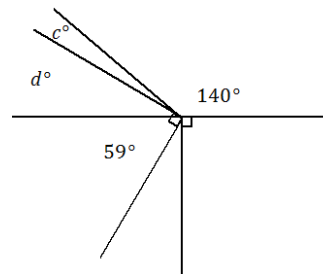

2. Lines \overleftrightarrow{BC} and \overleftrightarrow{EF} meet at A . Set up and solve an equation to find the value of x . Find the measurements of $\angle EAH$ and $\angle HAC$.

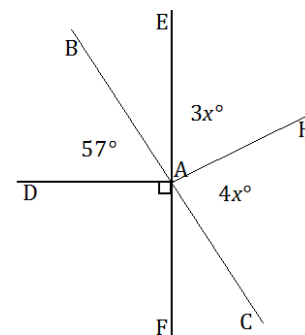

3. Five rays meet at a point. Set up and solve an equation to find the values of x . Find the measurements of $\angle DAG$ and $\angle GAH$.

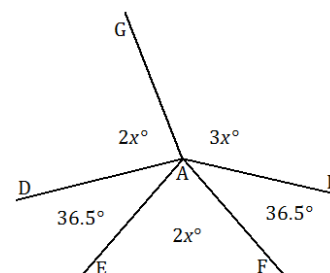

Eureka Math Module 6 - Geometry

4. Two perpendicular lines meet at the common vertex of seven rays. Set up and solve an equation to find the values of x and y .

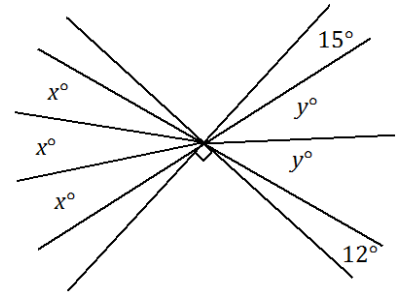

5. Two lines meet at the common vertex of two perpendicular rays. Set up and solve an equation to find the value of x . Find the measurements of $\angle CAE$ and $\angle BAG$.

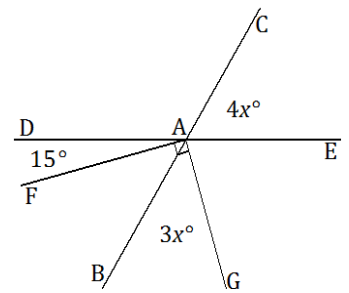

6. Five angles are at a point. The measurement of each angle is one of five consecutive, positive whole numbers.
- Determine the measurements of all five angles.
 - Compare the expressions you used for the three angles and their combined expression. Explain how they are equivalent and how they reveal different information about this situation.

Eureka Math Module 6 - Geometry

7. Let x° be the measurement of an angle. The ratio of the measurement of the complement of the angle to the measurement of the supplement of the angle is $\frac{1}{3}$. Use a tape diagram to find the measurement of this angle.

8. Two lines meet at a point. Set up and solve an equation to find the value of x . Find the measurement of one of the vertical angles.

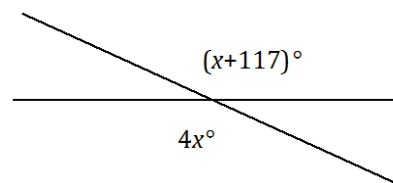

9. The difference between three times the measurement of the complement of an angle and the measurement of the supplement of that angle is 20° . What is the measurement of the angle?

Lesson 5 - Identical Triangles

Essential Questions:

Opening

When studying triangles, it is essential to be able to communicate about the parts of a triangle without any confusion. The following terms are used to identify particular angles or sides:

- between
- adjacent to
- opposite to
- included [side/angle]

Exercises 1-7:

Use the figure $\triangle ABC$ to fill in the following blanks.

1. $\angle A$ is _____ sides AB and AC .

2. $\angle B$ is _____ side AB and to side BC .

3. Side AB is _____ $\angle C$.

4. Side _____ is the included side of $\angle B$ and $\angle C$.

5. _____ is opposite to side AC

6. Side AB is between _____ and _____.

7. What is the included angle of AB and BC ? _____

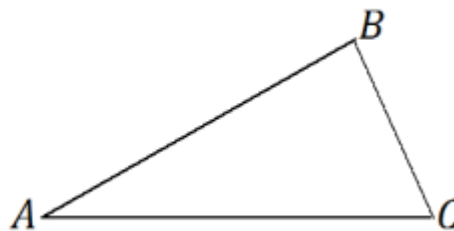

Eureka Math Module 6 - Geometry

Now that we know what to call the parts within a triangle, we consider how to discuss two triangles. We need to compare the parts of the triangles in a way that is easy to understand. To establish some alignment between the triangles, the vertices of the two triangles are paired up. This is called a correspondence. Specifically, a correspondence between two triangles is a pairing of each vertex of one triangle with one (and only one) vertex of the other triangle. A correspondence provides a systematic way to compare parts of two triangles.

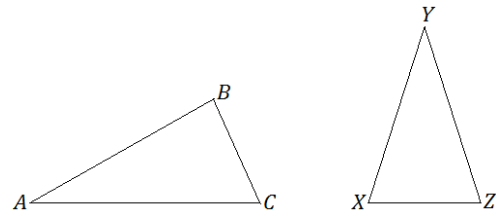

Figure 1

In Figure 1, we can choose to assign a correspondence so that A matches to X , B matches to Y , and C matches to Z . We notate this correspondence with double-arrows: $A \leftrightarrow X$, $B \leftrightarrow Y$, and $C \leftrightarrow Z$. This is just one of six possible correspondences between the two triangles. Four of the six correspondences are listed below; find the remaining two correspondences.

$$\begin{array}{l} A \longleftrightarrow X \\ B \longleftrightarrow Y \\ C \longleftrightarrow Z \end{array}$$

$$\begin{array}{l} A \longleftrightarrow X \\ B \longleftrightarrow Z \\ C \longleftrightarrow Y \end{array}$$

$$\begin{array}{l} A \longleftrightarrow Y \\ B \longleftrightarrow X \\ C \longleftrightarrow Z \end{array}$$

$$\begin{array}{l} A \longleftrightarrow Z \\ B \longleftrightarrow X \\ C \longleftrightarrow Y \end{array}$$

Eureka Math Module 6 - Geometry

A simpler way to indicate the triangle correspondences is to let the order of the vertices define the correspondence; i.e., the first corresponds to the first, the second to the second, and the third to the third. The correspondences above can be written in this manner. Write the remaining two correspondences in this way.

$$\begin{array}{ll} \triangle ABC \leftrightarrow \triangle XYZ & \triangle ABC \leftrightarrow \triangle XZY \\ \triangle ABC \leftrightarrow \triangle YXZ & \triangle ABC \leftrightarrow \triangle YZX \end{array}$$

With a correspondence in place, comparisons can be made about corresponding sides and corresponding angles. The following are corresponding vertices, angles, and sides for the triangle correspondence $\triangle ABC \leftrightarrow \triangle YXZ$. Complete the missing correspondences:

Vertices:	$A \leftrightarrow Y$	$B \leftrightarrow$	$C \leftrightarrow$
Angles:	$\angle A \leftrightarrow \angle Y$	$\angle B \leftrightarrow$	$\angle C \leftrightarrow$
Sides:	$AB \leftrightarrow YX$	$BC \leftrightarrow$	$CA \leftrightarrow$

Example 1

Triangle Correspondence	$\triangle ABC \leftrightarrow \triangle STR$
Correspondence of Vertices	
Correspondence of Angles	
Correspondence of Sides	

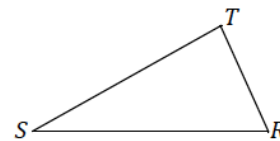
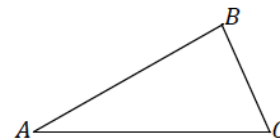

Eureka Math Module 6 - Geometry

Examine Figure 2. By simply looking, it is impossible to tell the two triangles apart unless they are labeled. They look exactly the same (just as identical twins look the same). One triangle could be picked up and placed on top of the other.

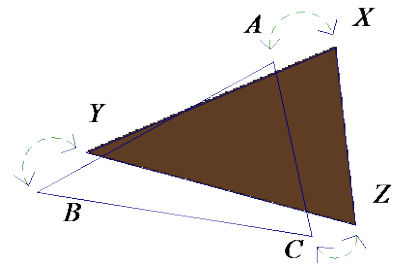

Figure

Two triangles are identical if there is a triangle correspondence so that corresponding sides and angles of each triangle is equal in measurement. In Figure 2, there is a correspondence that will match up equal sides and equal angles, $\triangle ABC \leftrightarrow \triangle XYZ$; we can conclude that $\triangle ABC$ is identical to $\triangle XYZ$. This is not to say that we cannot find a correspondence in Figure 2 so that unequal sides and unequal angles are matched up, but there certainly is one correspondence that will match up angles with equal measurements and sides of equal lengths, making the triangles identical.

In discussing identical triangles, it is useful to have a way to indicate those sides and angles that are equal. We mark sides with tick marks and angles with arcs if we want to draw attention to them. If two angles or two sides have the same number of marks, it means they are equal.

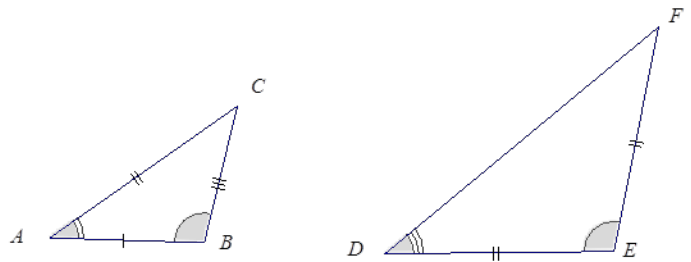

In this figure, $AC = DE = EF$, and $\angle B = \angle E$.

Example 2

Two identical triangles are shown below. Give a triangle correspondence that matches equal sides and equal angles.

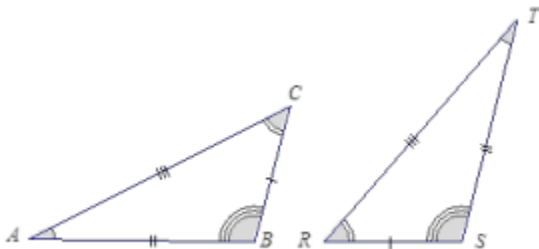

Eureka Math Module 6 - Geometry

Exercise 8

Sketch two triangles that have a correspondence. Describe the correspondence in symbols or words. Have a partner check your work.

Summary

Eureka Math Module 6 - Geometry



Lesson 5 - Independent Practice

Given the following triangle correspondences, use double arrows to show the correspondence between vertices, angles, and sides.

1.

Triangle Correspondence	$\triangle ABC \leftrightarrow \triangle RTS$
Correspondence of Vertices	
Correspondence of Angles	
Correspondence of Sides	

2.

Triangle Correspondence	$\triangle ABC \leftrightarrow \triangle FGE$
Correspondence of Vertices	
Correspondence of Angles	
Correspondence of Sides	

3.

Triangle Correspondence	$\triangle QRP \leftrightarrow \triangle WYX$
Correspondence of Vertices	
Correspondence of Angles	
Correspondence of Sides	

Directions for Problems 4-6: Name the angle pairs and side pairs to find a triangle correspondence that matches sides of equal length and angles of equal angles measurements

4.

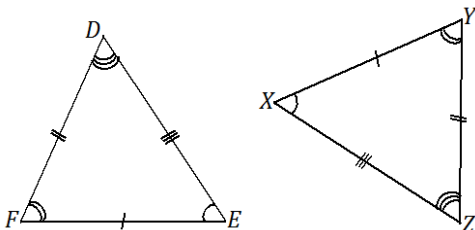

Eureka Math Module 6 - Geometry

5.

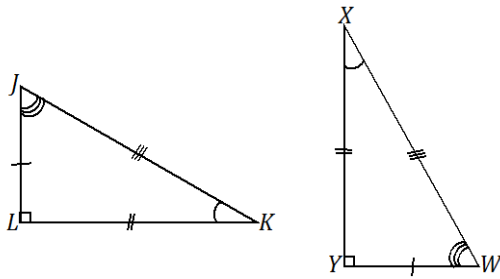

6.

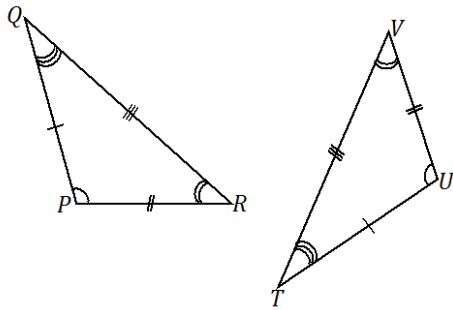

7. Consider the following points in the coordinate plane.

- a. How many different (non-identical) triangles can be drawn using any three of these six points as vertices?

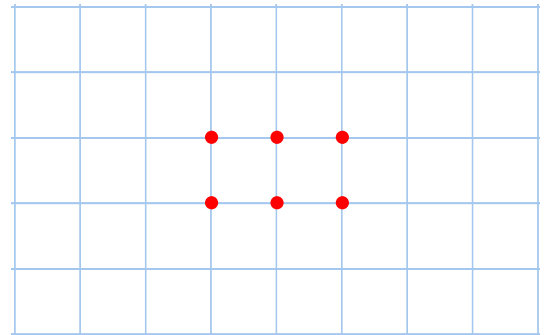

- b. How can we be sure that there are no more possible triangles?

Eureka Math Module 6 - Geometry

8. Quadrilateral $ABCD$ is identical with Quadrilateral $WXYZ$ with a correspondence $A \leftrightarrow W$, $B \leftrightarrow X$, $C \leftrightarrow Y$, and $D \leftrightarrow Z$.

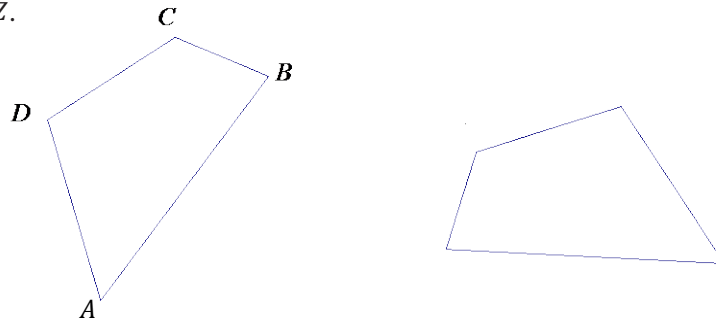

- In the figure below, label points W , X , Y , and Z on the second quadrilateral.
- Set up a correspondence between the side lengths of the two quadrilaterals that matches sides of equal length.
- Set up a correspondence between the angles of the two quadrilaterals that matches angles of equal measure.

Lesson 6 - Drawing Geometric Shapes

Essential Questions:

Exploratory Challenge

Use a ruler, protractor, and compass to complete the following problems. 1. Use your ruler to draw three segments of the following lengths: 4 cm, 7.2 cm, and 12.8 cm. Label each segment with its measurement.

Draw complementary angles so that one angle is 35° . Label each angle with its measurement. Are the angles required to be adjacent?

Draw vertical angles so that one angle is 125° . Label each angle formed with its measurement.

Eureka Math Module 6 - Geometry

Draw three distinct segments of lengths 2 cm, 4 cm, and 6 cm. Use your compass to draw three circles, each with a radius of one of the drawn segments. Label each radius with its measurement.

Draw three adjacent angles, a , b , c , so that $a = 25^\circ$, $b = 90^\circ$, and $c = 50^\circ$. Label each angle with its measurement.

Draw a rectangle $ABCD$ so that $AB = CD = 8\text{ cm}$ and $BC = AD = 3\text{ cm}$.

Eureka Math Module 6 - Geometry

Draw a segment AB that is 5 cm in length. Draw a second segment that is longer than AB and label one endpoint C . Use your compass to find a point on your second segment, which will be labeled D , so that $CD = AB$.

Draw a segment AB with a length of your choice. Use your compass to construct two circles.

- A circle with center A and radius AB
- A circle with a center B and radius BA .

Describe the construction in a sentence.

Draw a horizontal segment AB , w cm in length.

1. Label a point O on AB that is 4 cm from B .
2. Point O will be the vertex of an angle $\angle COB$
3. Draw ray OC so that the ray is above the AB and $\angle COB = 30^\circ$.
4. Draw a point P on AB that 4 cm from A .
5. Label p will be the vertex of an angle $\angle QPO$
6. Draw ray PQ so that the ray is above AB and $\angle QPO = 30^\circ$.

Eureka Math Module 6 - Geometry

Draw a segment AB of length 4 cm. Draw the same circle from A and from B (i.e., do not adjust your compass in between) with a radius of a length that allows the two circles to intersect in two distinct locations. Label the points where the two circles intersect C and D . Join A and C with a segment; join B and C with a segment. Join A and D with a segment; join B and D with a segment.

What kind of triangles are $\triangle ABC$ and $\triangle ABD$? Justify your response

Determine all possible measurements in the following triangle and use your tools to create a copy of it.

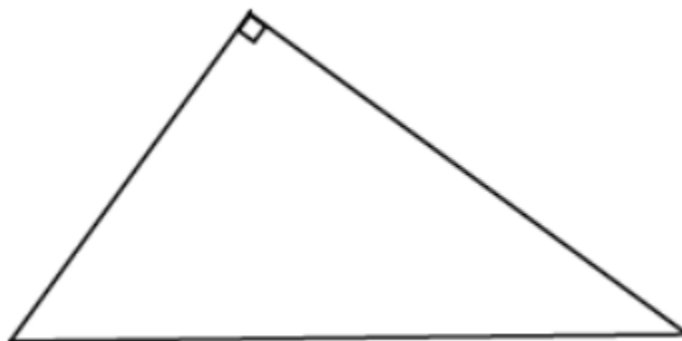

Summary

Eureka Math Module 6 - Geometry

6. Draw an isosceles $\triangle DEF$. Begin by drawing a horizontal segment DE that is 6 cm in length. Use your protractor to draw $\angle D$ and $\angle E$ so that the measurements of both angles are 30° . If the non horizontal rays of $\angle D$ and $\angle E$ do not already cross, extend each ray until the two rays intersect. Label the point of the intersection F . Label all side and angle measurements.

7. Draw a segment AB that is 7 cm in length. Draw a circle with center A and a circle with center B so that the circles are not the same side, but do intersect in two distinct locations. Label one of these intersections C . Join A and C and B to C to form $\triangle ABC$.

Eureka Math Module 6 - Geometry

8. Draw an isosceles trapezoid $WXYZ$ with two equal base angles, $\angle W$ and $\angle X$, that each measure 100° . Use your compass to create the two equal sides of the trapezoid. Leave arc marks as evidence of the use of your compass. Label all angle measurements. Explain how you constructed the trapezoid.

Lesson 7 - Drawing Parallelogram

Essential Questions:

Example 1: Use what you know about drawing parallel lines with a setsquare to draw rectangle ABCD with dimensions of your choice. State the steps you used to draw your rectangle, and compare those steps to those of a partner's.

Example 2: Use what your know about drawing parallel lines with a setsquare to draw rectangle ABCD with $AB = 3$ cm and $BC = 5$ cm. Write a plan for the steps you will take to draw ABCD.

Example 3: Use a setsquare, ruler, and protractor to draw parallelogram PQRS so that measurement of $\angle P = 50^\circ$, $PQ = 5$ cm, the measurement of $\angle Q = 130^\circ$, and the altitude to PQ is 4 cm.

Eureka Math Module 6 - Geometry

Exercise 1: Use a set, ruler, and protractor to draw parallelogram $DEFG$ so that the measurements of $\angle D = 40^\circ$, $DE = 3$ cm, the measurement of $\angle E = 140^\circ$, and the altitude to DE is 5 cm.

Example 4: Use a setsquare, ruler, protractor to draw a rhombus $ABCD$ so that the measurements of $\angle A = 80^\circ$, the measurements of $\angle B = 100^\circ$, and each side of the rhombus measures 7 cm.

Summary

Eureka Math Module 6 - Geometry

The following table contains partial information for parallelogram $ABCD$. Using no tools, make a sketch of the parallelogram. Then use a ruler, protractor, and setsquare to draw an accurate picture.

	$\angle A$	AB	Altitude to AB	BC	Altitude to BC
4.	45°	5 cm		4 cm	
5.	50°	3 cm		3 cm	
6.	60°	4 cm	4 cm		

7. Use what you know about drawing parallel lines with a setsquare to draw trapezoid $ABCD$ with parallel sides AB and CD . The length of $AB = 3$ cm, and the length of $CD = 5$ cm; the height between the parallel sides is 4 cm. Write a plan for the steps you will take to draw $ABCD$.

Eureka Math Module 6 - Geometry

8. Use the appropriate tools to draw rectangle FIND with $FI = 5$ cm, and $IN = 10$ cm.

9. Challenge: Determine the area of the largest rectangle that will fit inside an equilateral triangle with side length 5 cm.

Lesson 8 - Drawing Triangle

Essential Questions:

Exercise 1 - 2

1. Use your protractor and ruler to draw right triangle DEF. Label all sides and angle measurements.

a. Predict how many of the right triangles drawn in class are identical to the triangle you have drawn.

b. How many of the right triangles drawn in class are identical to the triangle you drew? Were you correct in your prediction?

2. Given the following three sides of $\triangle ABC$, use your compass to copy the triangle. The longest side has been copied for you already. Label the new triangle $A'B'C'$, and indicate all side and angle measurements. For a reminder of how to begin, refer to Lesson 6, Exploratory Challenge, Question 10.

A _____ B

B _____ C

A _____ C

A _____ C

Eureka Math Module 6 - Geometry

Exploratory Challenge

A triangle is to be drawn provided the following conditions: the measurement of two angles is 30° and 60° , and the length of a side is 10 cm. Note that where each of these measurements is positioned is not fixed.

a. How is the premise of this problem different from Exercise 2?	
b. Given these measurements, do you think it will be possible to draw more than one triangle so that the triangles drawn will be different from each other? Or do you think attempting to draw more than one triangle with these measurements will just keep producing the same triangle, just turned around or flipped about?	
c. Based on the provided measurements, draw $\triangle ABC$ so that $\angle A = 30^\circ$, $\angle B = 60^\circ$, and $AB = 10$ cm. Describe how the 10 cm side is positioned.	

Eureka Math Module 6 - Geometry

d. Now, use the same measurements, draw $\triangle A' B' C'$ so that $\angle A' = 30^\circ$, $\angle B' = 60^\circ$, and $A'C' = 10$ cm.

e. Last, again, using the same measurements, draw $\triangle A'' B'' C''$ so that $\angle A'' = 30^\circ$, $\angle B'' = 60^\circ$, and $B''C'' = 10$ cm.

f. Are the three drawn triangles identical? Justify your response using measurements.

Eureka Math Module 6 - Geometry

g. Draw $\triangle A''B''C''$ so that $\angle A'' = 30^\circ$, $\angle B'' = 60^\circ$, and $B''C'' = 10$ cm. Is it identical to any of the three triangles already drawn?

h. Draw another triangle that meets the criteria of this challenge. Is it possible to draw any other triangles that would be different from the three drawn above?

Summary

Lesson 9 - Conditions for a Unique Triangle-Three side and Two Sides are the Included Angle

Essential Questions:

Exploratory Challenge

1. A triangle XYZ exists with side lengths of the segments below. Draw $\triangle X'Y'Z'$ with the same side lengths as $\triangle XYZ$. Use your compass to determine the sides of $\triangle X'Y'Z'$. Use your ruler to measure side lengths. Leave all construction marks as evidence of your work, and label all side and angle measurements.

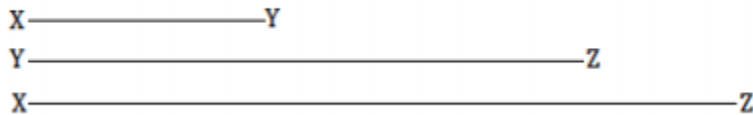

Under what condition is $\triangle X'Y'Z'$ drawn? Compare the triangle you drew to two of your peers' triangles.

Are the triangles identical?
Did the condition determine a unique triangle?

Use your construction to explain why. Do the results differ from your predictions?

Eureka Math Module 6 - Geometry

2. $\triangle ABC$ is located below. Copy the sides of the triangle to create $\triangle A'B'C'$. Use your compass to determine the sides of $\triangle A'B'C'$. Use your ruler to measure side lengths. Leave all construction marks as evidence of your work, and label all side and angle measurements. Under what condition is $\triangle A'B'C'$ drawn? Compare the triangle you drew to two of your peers' triangles. Are the triangles identical? Did the condition determine a unique triangle? Use your construction to explain why.

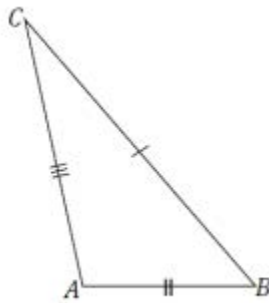

3. A triangle DEF has an angle of 40° adjacent to side lengths of 4 cm and 7 cm. Construct $\triangle D'E'F'$ with side lengths $D'E' = 4$ cm, $D'F' = 7$ cm, and included angle $\angle D' = 40^\circ$. Use your compass to draw the sides of $\triangle D'E'F'$. Use your ruler to measure side lengths. Leave all construction marks as evidence of your work, and label all side and angle measurements.

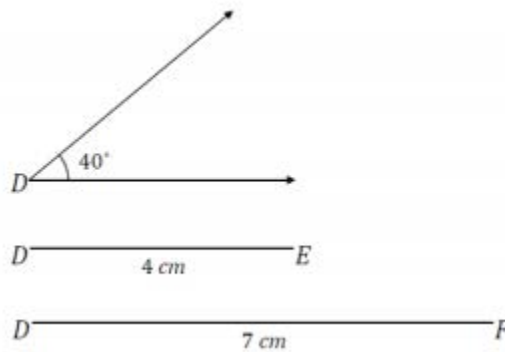

Under what condition is $\triangle D'E'F'$ drawn? Compare the triangle you drew to two of your peers' triangles. Did the condition determine a unique triangle? Use your construction to explain why.

Eureka Math Module 6 - Geometry

4. $\triangle XYZ$ has side lengths $XY = 2.5$ cm, $XZ = 4$ cm, and $\angle X = 120^\circ$. Draw $\triangle X'Y'Z'$ under the same conditions. Use your compass and protractor to draw the sides of $\triangle X'Y'Z'$. Use your ruler to measure side lengths. Leave all construction marks as evidence of your work, and label all side and angle measurements.

Under what condition is $\triangle X'Y'Z'$ drawn? Compare the triangle you drew to two of your peers' triangles. Are the triangles identical? Did the condition determine a unique triangle? Use your construction to explain why.

Summary

Eureka Math Module 6 - Geometry



Lesson 9 - Independent Practice

1. A triangle with side lengths 3 cm, 4 cm, and 5 cm exists. Use your compass and ruler to draw a triangle with the same side lengths. Leave all construction marks as evidence of your work, and label all side and angle measurements.

Under what condition is the triangle drawn? Compare the triangle you drew to two of your peers' triangles. Are the triangles identical? Did the condition determine a unique triangle? Use your construction to explain why.

2. Draw triangles under the conditions described below.
 - a. A triangle has side lengths 5 cm and 6 cm. Draw two non-identical triangles that satisfy these conditions. Explain why your triangles are not identical.

- b. A triangle has a side length of 7 cm opposite a 45° angle. Draw two non-identical triangles that satisfy these conditions. Explain why your triangles are not identical.

Eureka Math Module 6 - Geometry

3. Diagonal BD is drawn in square $ABCD$. Describe what condition(s) can be used to justify that $\triangle ABD$ is identical to $\triangle CBD$. What can you say about the measures of $\angle ABD$ and $\angle CBD$? Support your answers with a diagram and explanation of the correspondence(s) that exists.
4. Diagonals BD and AC are drawn in square $ABCD$. Show that $\triangle ABC$ is identical to $\triangle BAD$, and then use this information to show that the diagonals are equal in length.
5. Diagonal QS is drawn in rhombus $PQRS$. Describe the condition(s) that can be used to justify that $\triangle PQS$ is identical to $\triangle RQS$. Can you conclude that the measures of $\angle PQS$ and $\angle RQS$ are the same? Support your answer with a diagram and explanation of the correspondence(s) that exists.

Eureka Math Module 6 - Geometry

6. Diagonals QS and PR are drawn in rhombus PQRS and meet at point T. Describe the condition(s) that can be used to justify that $\triangle PQT$ is identical to $\triangle RQT$. Can you conclude that the line segments PR and QS are perpendicular to each other? Support your answers with a diagram and explanation of the correspondence(s) that exists.

Lesson 10 - Conditions for a Unique Triangle- Two Angles and A Given Side

Essential Questions:

Exploratory Challenge

1. A triangle XYZ has angle measures $\angle X = 30^\circ$ and $\angle Y = 50^\circ$, and included side $XY = 6$ cm. Draw $\triangle X'Y'Z'$ under the same condition as $\triangle XYZ$. Leave all construction marks as evidence of your work, and label all side and angle measurements.

Under what condition is $\triangle X'Y'Z'$ drawn? Compare the triangle you drew to two of your peers' triangles. Are the triangles identical? Did the condition determine a unique triangle? Use your construction to explain why.

2. A triangle RST has angle measures $\angle S = 90^\circ$ and $\angle T = 45^\circ$ and included side $ST = 7$ cm. Draw $\triangle R'S'T'$ under the same condition. Leave all construction marks as evidence of your work, and label all side and angle measurements.

Under what condition is $\triangle R'S'T'$ drawn? Compare the triangle you drew to two of your peers' triangles. Are the triangles identical? Did the condition determine a unique triangle? Use your construction to explain why.

Eureka Math Module 6 - Geometry

3. A triangle JKL has angle measures $\angle J = 60^\circ$ and $\angle L = 25^\circ$ and included side $KL = 5$ cm. Draw $\triangle J'K'L'$ under the same condition. Leave all construction marks as evidence of your work, and label all side and angle measurements.

Under what condition is $\triangle J'K'L'$ drawn? Compare the triangle you drew to two of your peers' triangles. Are the triangles identical? Did the condition determine a unique triangle? Use your construction to explain why.

4. A triangle ABC has angle measures $\angle C = 35^\circ$ and $\angle B = 105^\circ$ and included side $AC = 7$ cm. Draw $\triangle A'B'C'$ under the same condition. Leave all construction marks as evidence of your work, and label all side and angle measurements.

Under what condition is $\triangle ABC$ drawn? Compare the triangle you drew to two of your peers' triangles. Are the triangles identical? Did the condition determine a unique triangle? Use your construction to explain why.

Summary

Eureka Math Module 6 - Geometry

3. Points A, Z, and E are collinear, and $\angle B = \angle D$. What can be concluded about $\triangle ABZ$ and $\triangle EDZ$? Justify your answer.

4. Draw $\triangle ABC$ so that $\angle A$ has a measurement of 60° , $\angle B$ has a measurement of 60° , and AB has a length of 8 cm. What are the lengths of the other sides?

Eureka Math Module 6 - Geometry

5. Draw $\triangle ABC$ so that $\angle A$ has a measurement of 30° , $\angle B$ has a measurement of 60° , and BC has a length of 5 cm. What is the length of the longest side?

Lesson 11 - Conditions on Measurements that Determine a Triangle

Essential Questions:

Exploratory Challenge 1

a. Can any three side lengths form a triangle? Why or why not?	
b. Draw a triangle according to these instructions: <ul style="list-style-type: none">• Draw segment AB of length 10 cm in your notebook.• Draw segment BC of length 3 cm on one piece of patty paper.• Draw segment AC of length 5 cm on the other piece of patty paper.• Line up the appropriate endpoint on each piece of patty paper with the matching endpoint on segment AB.• Use your pencil point to hold each patty paper in place, and adjust the paper to form $\triangle ABC$.	
c. What do you notice?	
d. What must be true about the sum of the lengths of AC and BC if the two segments were to just meet? Use your patty paper to verify your answer.	

Eureka Math Module 6 - Geometry

e. Based on your conclusion for part (d), what if $BC = 3$ cm as you originally had, but $AC = 10$ cm in length. Could you form $\triangle ABC$?

f. What must be true about the sum of the lengths of AC and BC if the two segments were to meet and form a triangle?

Exercise 1

Two sides of $\triangle DEF$ have lengths of 5 cm and 8 cm. What are all the possible whole-number lengths for the remaining side?

Exploratory Challenge 2

a. Which of the following conditions determine a triangle? Follow the instructions to try and draw $\triangle ABC$. Segment AB has been drawn for you as a starting point in each case.

i. Choose measurements of $\angle A$ and $\angle B$ for $\triangle ABC$ so that the sum of measurements is greater than 180° . Label your diagram.

Your chosen angle measurements:

$\angle A =$ $\angle B =$

Were you able to form a triangle? Why or why not?



ii. Choose measurements of $\angle A$ and $\angle B$ for $\triangle ABC$ so that the measurement of $\angle A$ is supplementary to the measurement of $\angle B$. Label your diagram.

Your chosen angle measurements:

$\angle A =$ $\angle B =$

Were you able to form a triangle? Why or why not?



Eureka Math Module 6 - Geometry

iii. Choose measurements of $\angle A$ and $\angle B$ for $\triangle ABC$ so that the sum of measurements is less than 180° . Label your diagram.

Your chosen angle measurements:

$\angle A =$ $\angle B =$

Were you able to form a triangle? Why or why not?



b. Which condition must be true regarding angle measurements in order to determine a triangle?

c. Measure and label the formed triangle in part (a) with all three side lengths and the angle measurement for $\angle C$. Now, use a protractor, ruler, and compass to draw $\triangle A'B'C'$ with the same angle measurements but side lengths that are half as long.

d. Do the three angle measurements of a triangle determine a unique triangle? Why or why not?

Eureka Math Module 6 - Geometry

Summary

Exercise 2

Which of the following sets of angle measurements determines a triangle?

a. $30^\circ, 120^\circ$	
b. $125^\circ, 55^\circ$	
c. $105^\circ, 80^\circ$	
d. $90^\circ, 89^\circ$	
e. $91^\circ, 89^\circ$	
Choose one example from above that does determine a triangle and one that does not. For each, explain why it does or does not determine a triangle using words and a diagram.	

Eureka Math Module 6 - Geometry



Lesson 11 - Independent Practice

1. Decide whether each set of three given lengths determines a triangle. For any set of lengths that does determine a triangle, use a ruler and compass to draw the triangle. Label all side lengths. For sets of lengths that do not determine a triangle, write "Does not determine a triangle," and justify your response.
 - a. 3 cm, 4 cm, 5 cm
 - b. 1 cm, 4 cm, 5 cm
 - c. 1 cm, 5 cm, 5 cm
 - d. 8 cm, 3 cm, 4 cm
 - e. 8 cm, 8 cm, 4 cm
 - f. 4 cm, 4 cm, 4 cm

Eureka Math Module 6 - Geometry

2. For each angle measurement below, provide one angle measurement that will determine a triangle and one that will not determine a triangle. Provide a brief justification for the angle measurements that will not form a triangle. Assume that the angles are being drawn to a horizontal segment AB ; describe the position of the non-horizontal rays of angles $\angle A$ and $\angle B$.

$\angle A$	$\angle B$: A Measurement that Determines a Triangle	$\angle B$: A Measurement that Does Not Determine a Triangle	Justification for No Triangle
40°			
100°			
90°			
135°			

3. For the given side lengths, provide the minimum and maximum whole-number side lengths that determine a triangle.

Given Side Lengths	Minimum Whole Number Third Side Length	Maximum Whole Number Third Side Length
5 cm, 6 cm		
3 cm, 7 cm		
4 cm, 10 cm		
1 cm, 12 cm		

Eureka Math Module 6 - Geometry

- c. A ruler and compass are instrumental in determining where C is located.
- Even though the length of segment AC is unknown, extend the ray AC in anticipation of the intersection with segment BC .
 - Draw segment BC with length 3 cm away from the drawing of the triangle.
 - Adjust your compass to the length of BC .
 - Draw a circle with center B and a radius equal to BC , or 3 cm.
- d. How many intersections does the circle make with segment AC ? What does each intersection signify?
- e. Complete the drawing of $\triangle ABC$.
- f. Did the results of your drawing differ from your prediction?

2. Now attempt to draw $\triangle DEF$ in the space below, provided $DE = 5$ cm, $EF = 3$ cm, and $\angle F = 90^\circ$. Continue with the rest of the problem as you work on your drawing.
- How are these conditions different from those in Exercise 1, and do you think the criteria will determine a unique triangle?
 - What is the relationship between the given parts of $\triangle DEF$?
 - Describe how you will determine the position of DE .
 - How many intersections does the circle make FE .
 - Complete the drawing of $\triangle DEF$. How is the outcome $\triangle DEF$ different from that of $\triangle ABC$?
 - Did your results differ from your prediction?

Eureka Math Module 6 - Geometry

3. Now attempt to draw $\triangle JKL$, provided $KL = 8$ cm, $KJ = 4$ cm, and $\angle J = 120^\circ$. Use what you drew in exercises 1 and 2 to complete the full drawing.

4. Review the conditions provided for each of the three triangles in the Exploratory Challenge, and discuss the uniqueness of the resulting drawing in each case.

Summary



Lesson 12 - Independent Practice

1. In each of the triangles below, two sides and a non-included acute angle are marked. Use a compass to draw a nonidentical triangle that has the same measurements as the marked angle and marked sides (look at Exercise 1, part (e) of the Exploratory Challenge as a reference). Draw the new triangle on top of the old triangle. What is true about the marked angles in each triangle that results in two non-identical triangles under this condition?

a.

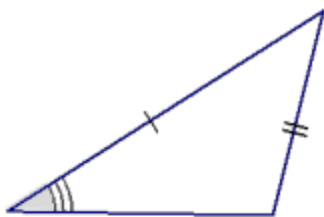

b.

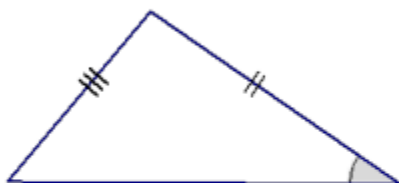

c.

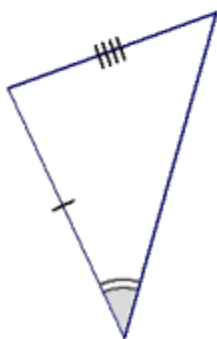

Eureka Math Module 6 - Geometry

2. Sometimes two sides and a non-included angle of a triangle determine a unique triangle, even if the angle is acute. In the following two triangles, copy the marked information (i.e., two sides and a non-included acute angle), and discover which determines a unique triangle. Measure and label the marked parts. In each triangle, how does the length of the marked side adjacent to the marked angle compare with the length of the side opposite the marked angle? Based on your drawings, specifically state when the two sides and acute nonincluded angle condition determines a unique triangle.

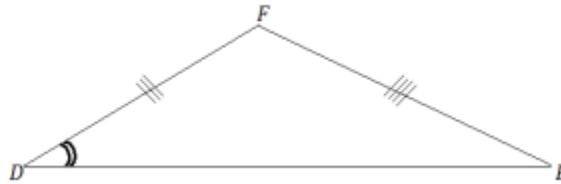
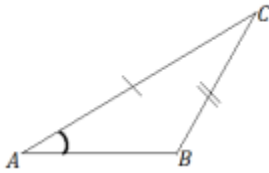

3. A sub-condition of the two sides and non-included angle is provided in each row of the following table. Decide whether the information determines a unique triangle. Answer with a yes, no, or maybe (for a case that may or may not determine a unique triangle).

	Condition	Determines a Unique Triangle?
1	Two sides and a non-included 90° angle.	
2	Two sides and an acute, non-included angle.	
3	Two sides and a non-included 140° angle.	
4	Two sides and a non-included 20° angle, where the side adjacent to the angle is shorter than the side opposite the angle.	
5	Two sides and a non-included angle.	
6	Two sides and a non-included 70° angle, where the side adjacent to the angle is longer than the side opposite the angle.	

Lesson 13 - Checking for Identical Triangles

Essential Questions:

Opening Exercise

a. List all the conditions that determine unique triangles.

b. How are the terms identical and unique related?

Each of the following problems gives two triangles. State whether the triangles are identical, not identical, or not necessarily identical. If the triangles are identical, give the triangle conditions that explain why, and write a triangle correspondence that matches the sides and angles. If the triangles are not identical, explain why. If it is not possible to definitively determine whether the triangles are identical, write "the triangles are not necessarily identical," and explain your reasoning.

Example 1

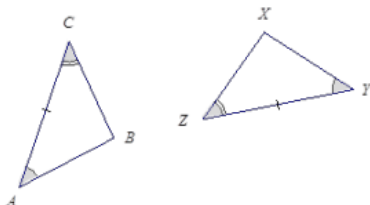

Eureka Math Module 6 - Geometry

Exercises 1 - 3

1.

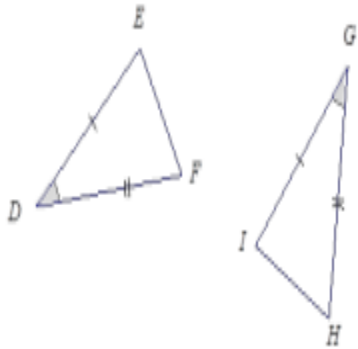

2.

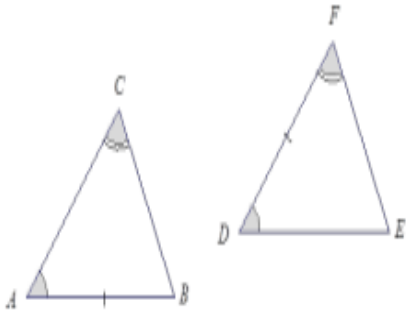

3.

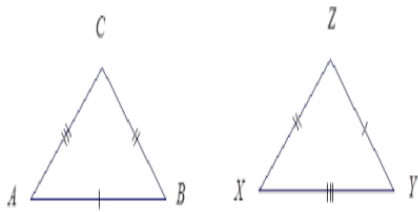

Eureka Math Module 6 - Geometry

In Example 2 and Exercises 4-6, three pieces of information are given for $\triangle ABC$ and $\triangle XYZ$. Draw, freehand, the two triangles (do not worry about scale), and mark the given information. If the triangles are identical, give a triangle correspondence that matches equal angles and equal sides. Explain your reasoning.

Example 2	
$AB = XZ, AC = XY, \angle A = \angle X$	
Exercises 4 - 6	
4. $\angle A = \angle Z, \angle B = \angle Y, AB = YZ$	
5. $\angle A = \angle Z, \angle B = \angle Y, BC = XY$	
6. $\angle A = \angle Z, \angle B = \angle Y, BC = XZ$	

Summary

Eureka Math Module 6 - Geometry



Lesson 13 - Independent Practice

In each of the following four problems, two triangles are given. State whether the triangles are identical, not identical, or not necessarily identical. If possible, give the triangle conditions that explain why the triangles are identical, and write a triangle correspondence that matches the sides and angles. If the triangles are not identical, explain why. If it is not possible to definitively determine whether the triangles are identical, write "the triangles are not necessarily identical," and explain your reasoning.

1.

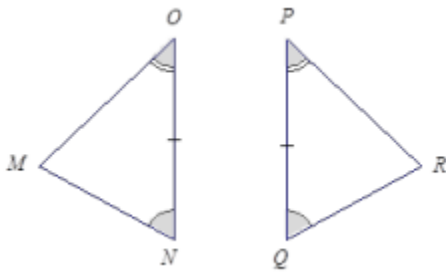

2.

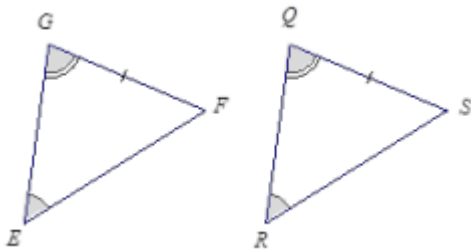

3.

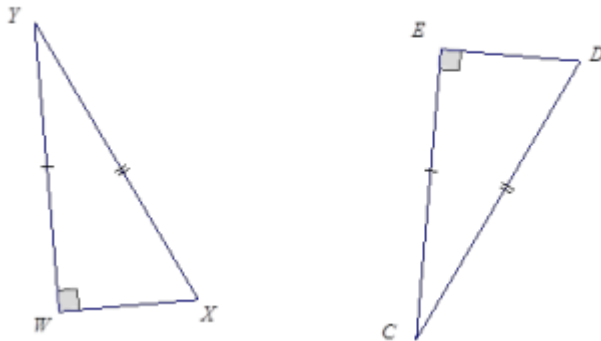

Eureka Math Module 6 - Geometry

4.



For Problems 5-8, three pieces of information are given for $\triangle AAAAAA$ and $\triangle YYYYYY$. Draw, freehand, the two triangles (do not worry about scale), and mark the given information. If the triangles are identical, give a triangle correspondence that matches equal angles and equal sides. Explain your reasoning.

5. $AB = YZ, BC = ZX, AC = YX$

6. $AB = ZY, BC = ZX, \angle C = \angle Y$

7. $AB = XZ, \angle A = \angle Z, \angle C = \angle Y$

8. $AB = XY, AC = YZ, \angle C = \angle Z$

Lesson 14 - Checking for Identical Triangle

Essential Questions:

Classwork

In each of the following problems, determine whether the triangles are identical, not identical, or not necessarily identical; justify your reasoning. If the relationship between the two triangles yields information that establishes a condition, describe the information. If the triangles are identical, write a triangle correspondence that matches the sides and angles.

Example 1

What is the relationship between the two triangles below?

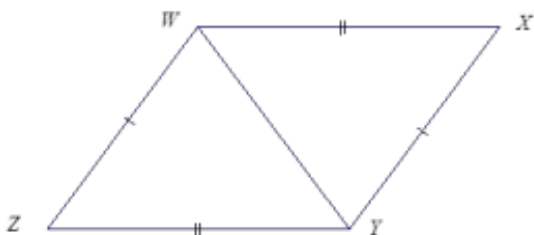

Eureka Math Module 6 - Geometry

Exercises 1 - 2

1. Are the triangles identical? Justify your reasoning.

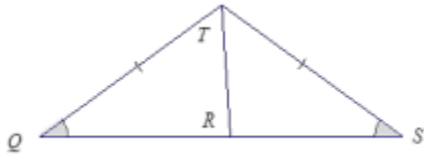

2. Are the triangles identical? Justify your reasoning.

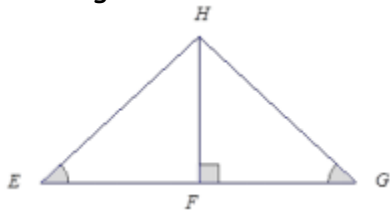

Example 2

- Are the triangles identical? Justify your reasoning.

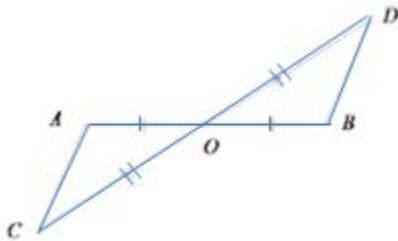

Exercises 3 - 8

3. Are the triangles identical? Justify your reasoning.

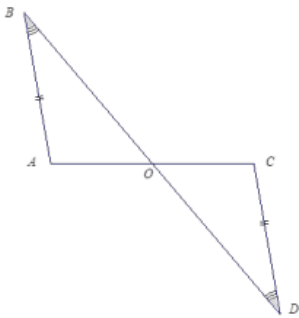

Eureka Math Module 6 - Geometry

4. Are the triangles identical? Justify your reasoning.

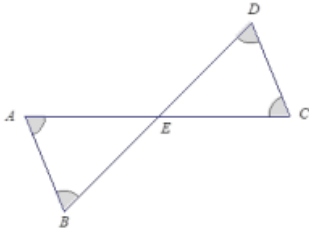

5. Are the triangles identical? Justify your reasoning.

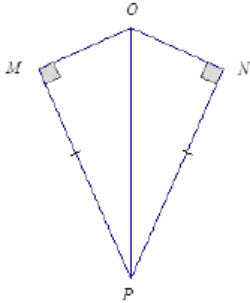

6. Are the triangles identical? Justify your reasoning.

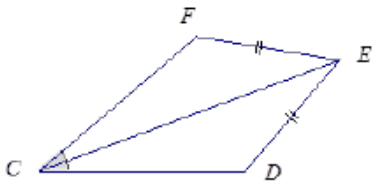

7. Are the triangles identical? Justify your reasoning.

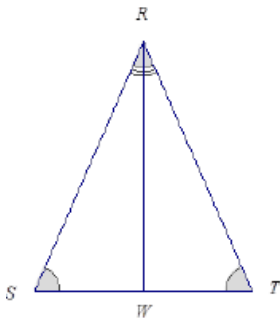

Eureka Math Module 6 - Geometry

8. Create your own labeled diagram and set of criteria for a pair of triangles. Ask a neighbor to determine whether the triangles are identical based on the provided information.

Summary

Eureka Math Module 6 - Geometry



Lesson 14 - Independent Practice

In the following problems, determine whether the triangles are identical, not identical, or not necessarily identical; justify your reasoning. If the relationship between the two triangles yields information that establishes a condition, describe the information. If the triangles are identical, write a triangle correspondence that matches the sides and angles.

<p>1.</p>	<p>2.</p>
<p>3.</p>	<p>4.</p>

Eureka Math Module 6 - Geometry

5.

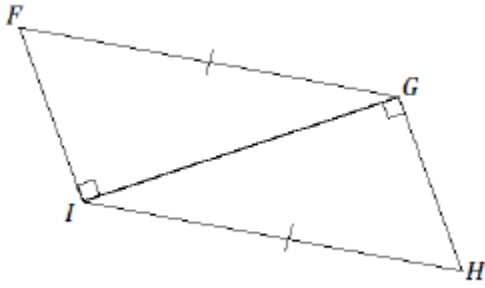

6.

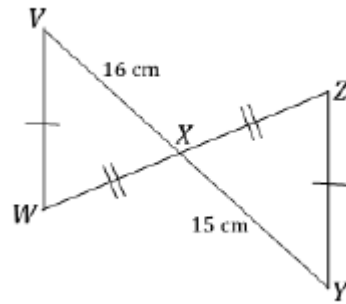

7.

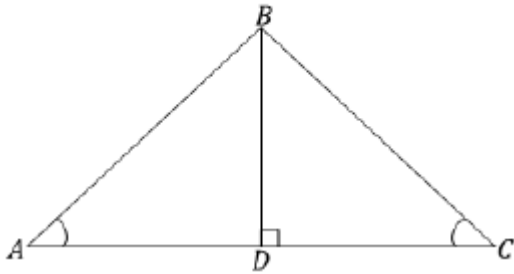

8. Are there any identical triangles in this diagram?

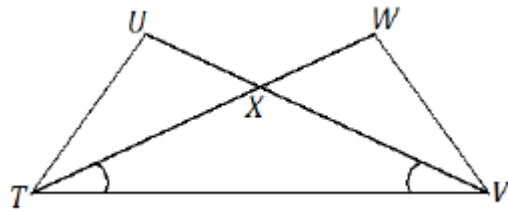

9.

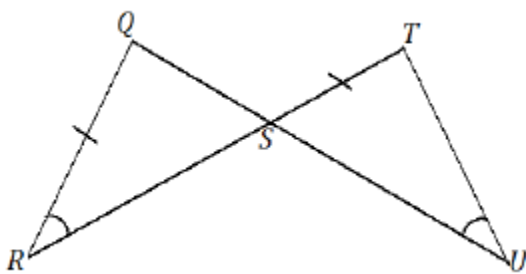

10.

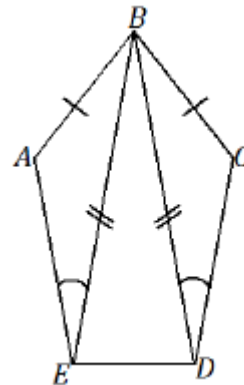

Lesson 15 - Using Unique Triangles to Solve Real-World and Mathematical Problems

Essential Questions:

Example 1

A triangular fence with two equal angles, $\angle S = \angle T$, is used to enclose some sheep. A fence is constructed inside the triangle that exactly cuts the other angle into two equal angles: $\angle SRW = \angle TRW$. Show that the gates, represented by SW and WT , are the same width.

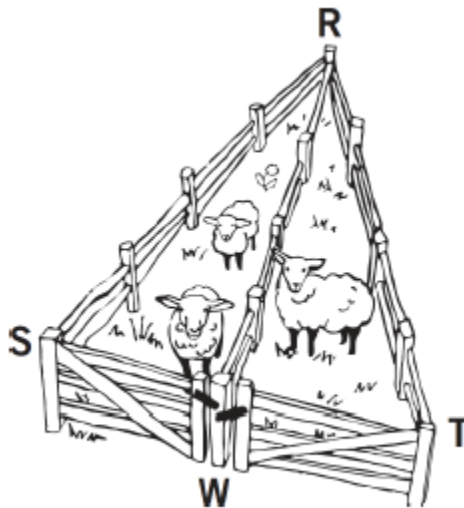

Example 2

In $\triangle ABC$, $AB = BC$, John says that the triangle correspondence $\triangle ABC \leftrightarrow \triangle BAC$ matches two sides and the included angle and shows that $\angle A = \angle B$. Is John correct?

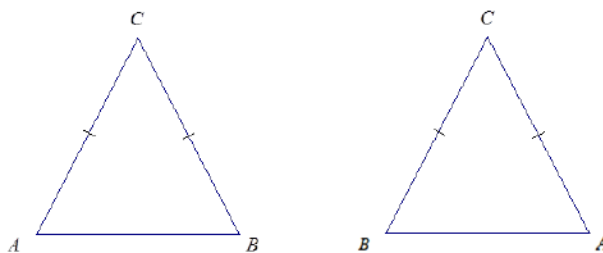

Eureka Math Module 6 - Geometry

Exercises 1-4

1. Mary puts the center of her compass at the vertex O of the angle and locates points A and B on the sides of the angle. Next, she centers her compass at each of A and B to locate point C . Finally, she constructs the ray OC . Explain why $\angle BOC = \angle AOC$.

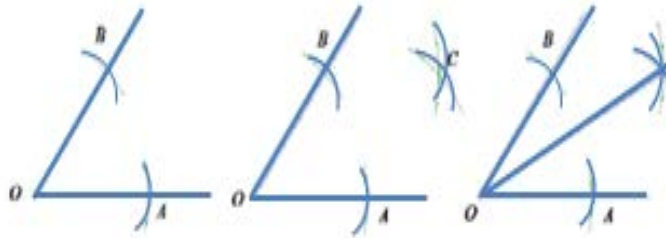

2. Quadrilateral $ACBD$ is a model of a kite. The diagonals AB and CD represent the sticks that help keep the kite rigid.

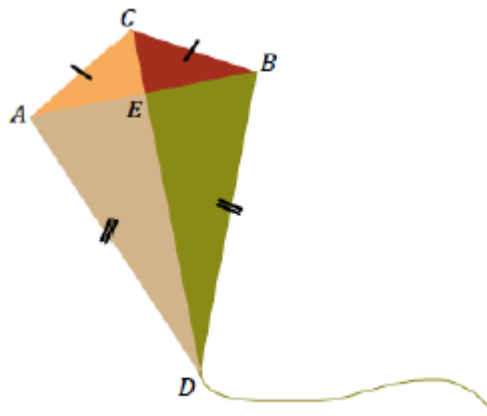

- a. John says that $\angle ACD = \angle BCD$. Can you use identical triangles to show that John is correct?

- b. Jill says that the two sticks are perpendicular to each other. Use the fact that $\angle ACD = \angle BCD$ and what you know about identical triangles to show $\angle AEC = 90^\circ$.

- c. John says that Jill's triangle correspondence that shows the sticks are perpendicular to each other also shows that the sticks cross at the midpoint of the horizontal stick. Is John correct? Explain.

Eureka Math Module 6 - Geometry

3. In $\triangle ABC$, $\angle A = \angle B$. Jill says that the triangle correspondence $\triangle ABC \leftrightarrow \triangle BAC$ matches two sides and the included angle and shows that $AC = BC$. Is Jill correct?

4. Right triangular corner flags are used to mark a soccer field. The vinyl flags have a base of 40 cm and a height of 14 cm.

- a. Mary says that the two flags can be obtained by cutting a rectangle that is 40 cm \times 14 cm on the diagonal. Will that create two identical flags? Explain.
- b. Will measures the two non-right angles on a flag and adds the measurements together. Can you explain, without measuring the angles, why his answer is 90° ?

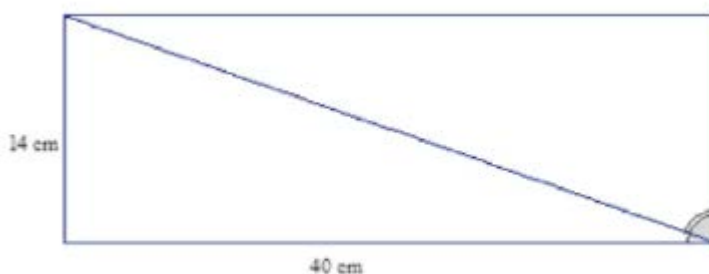

Summary



Lesson 15 - Independent Practice

1. Jack is asked to cut a cake into 8 equal pieces. He first cuts it into equal fourths in the shape of rectangles, and then he cuts each rectangle along a diagonal. Did he cut the cake into 8 equal pieces? Explain.

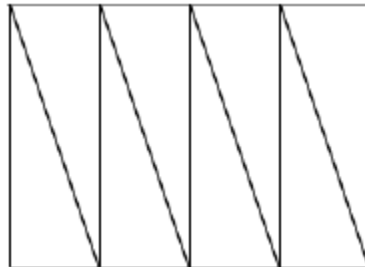

2. The bridge below, which crosses a river, is built out of two triangular supports. The point M lies on BC . The beams represented by AM and DM are equal in length, and the beams represented by AB and DC are equal in length. If the supports were constructed so that $\angle A$ and $\angle D$ are equal in measurement, is point M the midpoint of BC ? Explain.

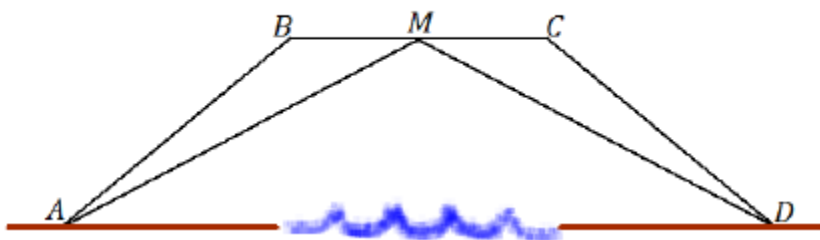

Lesson 16 - Slicing a Right Rectangular Prism with a Plane

Essential Questions:

Example 1

Consider a ball B . Figure 3 shows one possible slice of B .

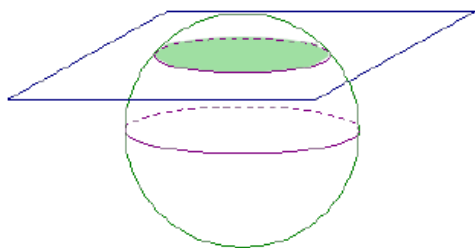

Figure 3. A Slice of Ball B

-
- What figure does the slicing plane form?
Students may choose their method of representation of the slice (e.g., drawing a 2D sketch, a 3D sketch, or describing the slice in words).
 - Will all slices that pass through B be the same size? Explain your reasoning.
 - How will the plane have to meet the ball so that the plane section consists of just one point?

Eureka Math Module 6 - Geometry

Example 2

The right rectangular prism in Figure 4 has been sliced with a plane parallel to face $ABCD$. The resulting slice is a rectangular region that is identical to the parallel face.

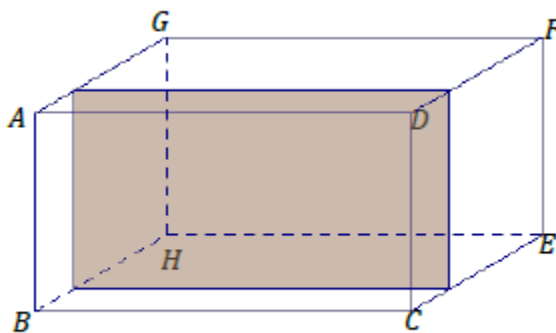

Figure 4

a. Label the vertices of the rectangular region defined by the slice as $WXYZ$.	
b. To which other face is the slice parallel and identical?	
c. Based on what you know about right rectangular prisms, which faces must the slice be perpendicular to?	

Eureka Math Module 6 - Geometry

Exercise 1:

Discuss the following questions with your group.

1. The right rectangular prism in Figure 5 has been sliced with a plane parallel to face $LMON$.

- a. Label the vertices of the rectangle defined by the slice as $RSTU$.

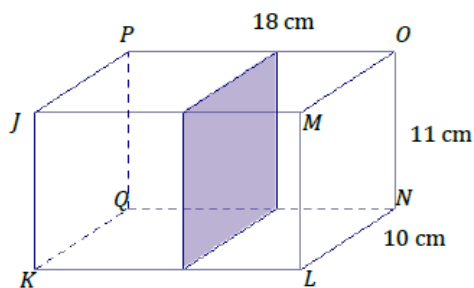

Figure 5

- b. What are the dimensions of the slice?

- c. Based on what you know about right rectangular prisms, which faces must the slice be perpendicular to?

Eureka Math Module 6 - Geometry

Example 3

The right rectangular prism in Figure 6 has been sliced with a plane perpendicular to $BCEH$. The resulting slice is a rectangular region with a height equal to the height of the prism.

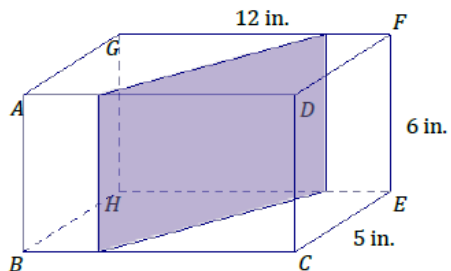

Figure 6

- Label the vertices of the rectangle defined by the slice as $WXYZ$.
- To which other face is the slice perpendicular?
- What is the length of ZY ?
- Joey looks at $WXYZ$ and thinks that the slice may be a parallelogram that is not a rectangle. Based on what is known about how the slice is made, can he be right? Justify your reasoning.

Eureka Math Module 6 - Geometry

Exercises 2 - 6

In the following exercises, the points at which a slicing plane meets the edges of the right rectangular prism have been marked. Each slice is either parallel or perpendicular to a face of the prism. Use a straightedge to join the points to outline the rectangular region defined by the slice, and shade in the rectangular slice.

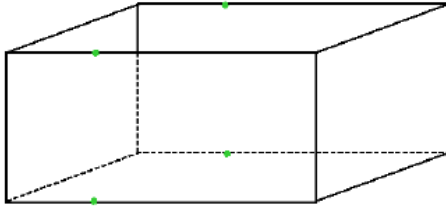
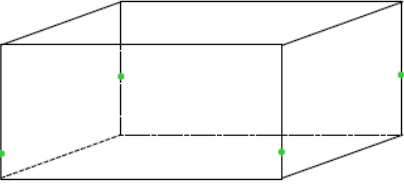
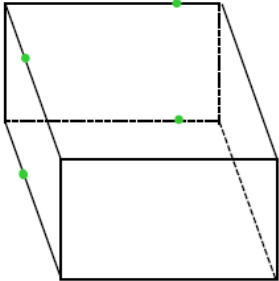
2. A slice parallel to a face	
3. A slice perpendicular to a face	
4. A slice perpendicular to a face	

Eureka Math Module 6 - Geometry

In Exercises 5-6, the dimensions of the prisms have been provided. Use the dimensions to sketch the slice from each prism, and provide the dimensions of each slice.

5. A slice parallel to a face

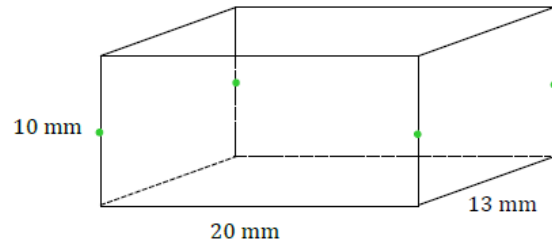

6. A slice perpendicular to a face

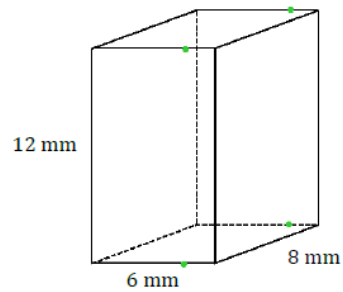

Summary



Lesson 16 - Independent Practice

A right rectangular prism is shown along with line segments that lie in a face. For each line segment, draw and give the approximate dimensions of the slice that results when the slicing plane contains the given line segment and is perpendicular to the face that contains the line segment.

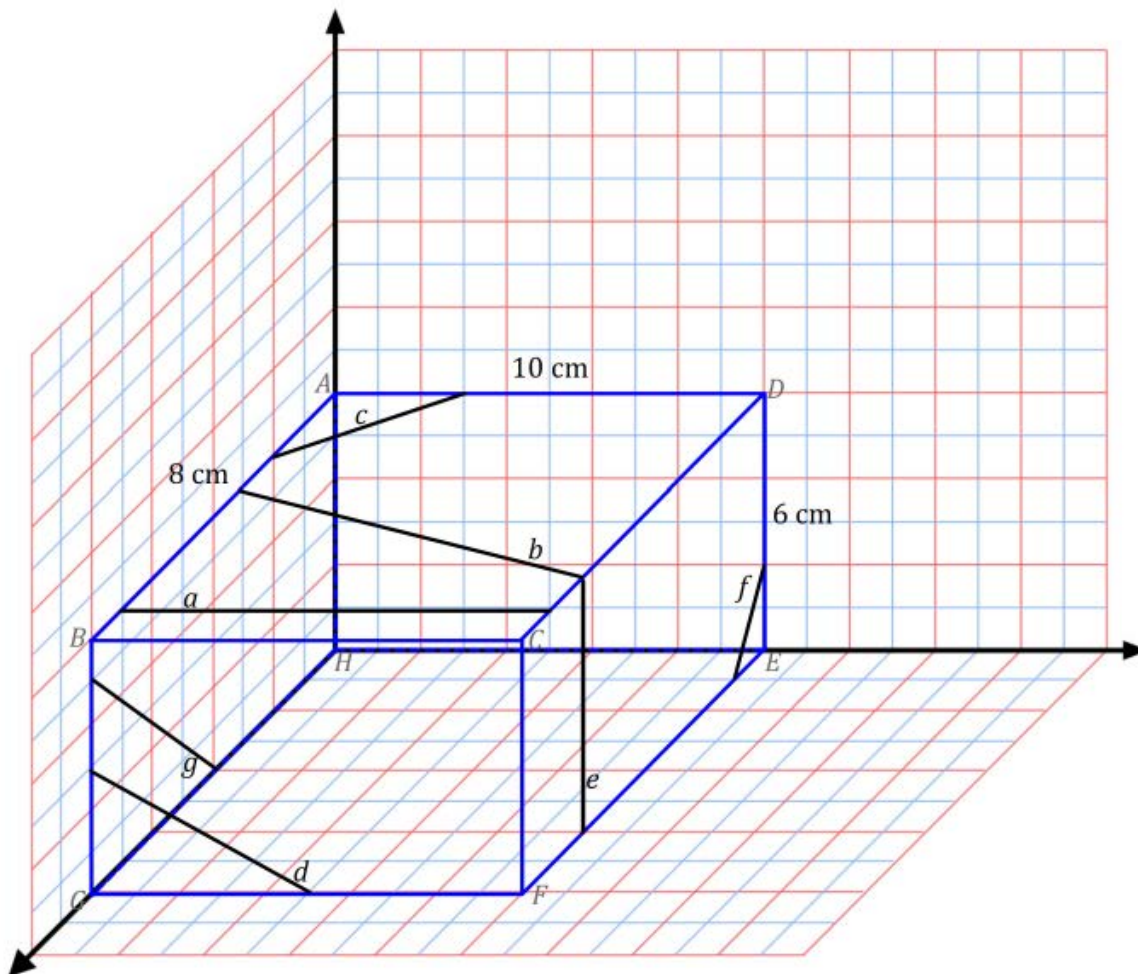

Eureka Math Module 6 - Geometry

a.

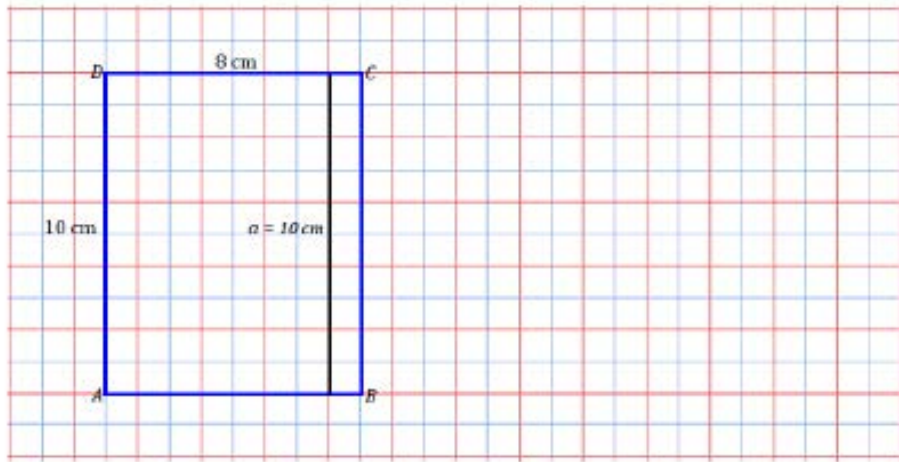

b.

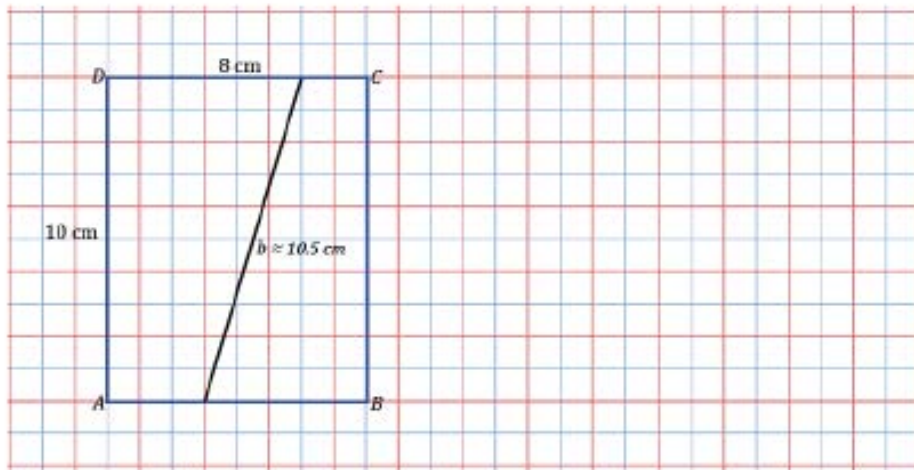

c.

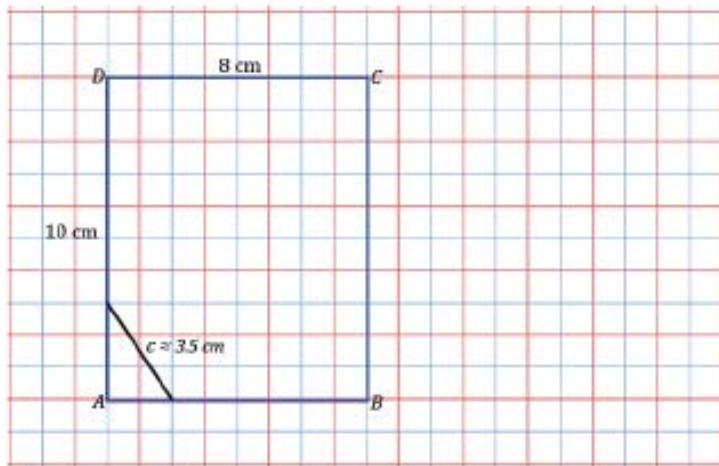

Eureka Math Module 6 - Geometry

d.

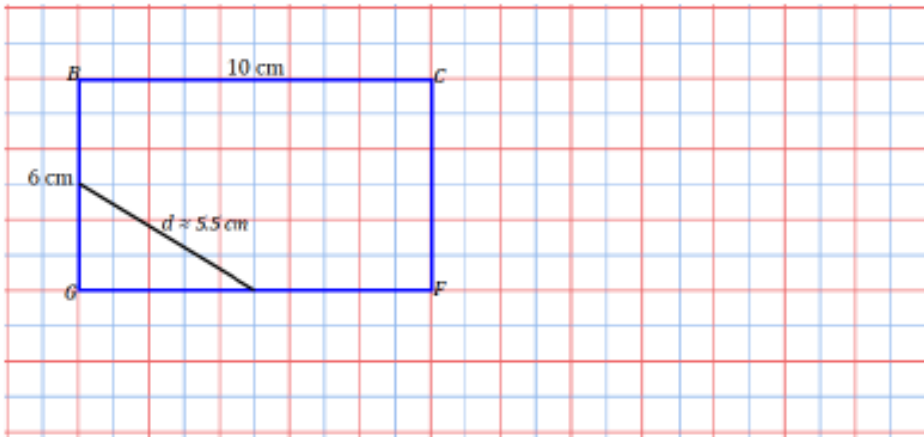

e.

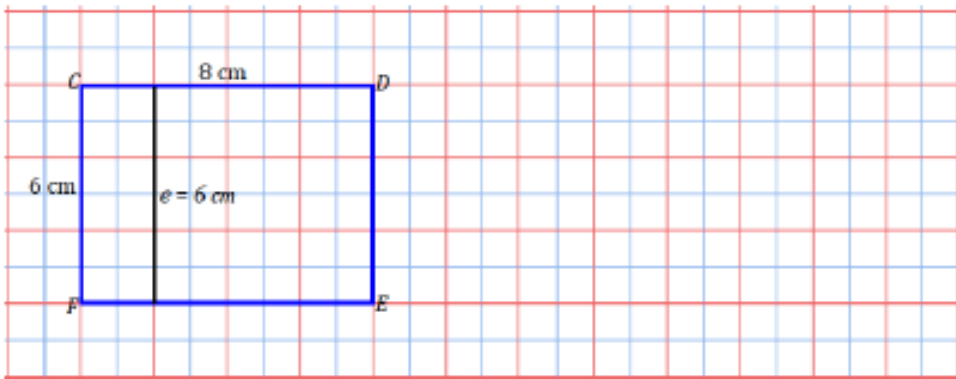

f.

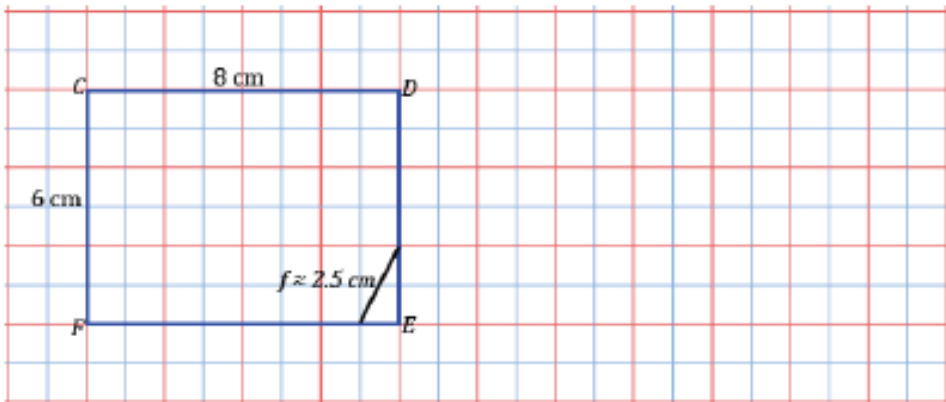

Eureka Math Module 6 - Geometry

E-

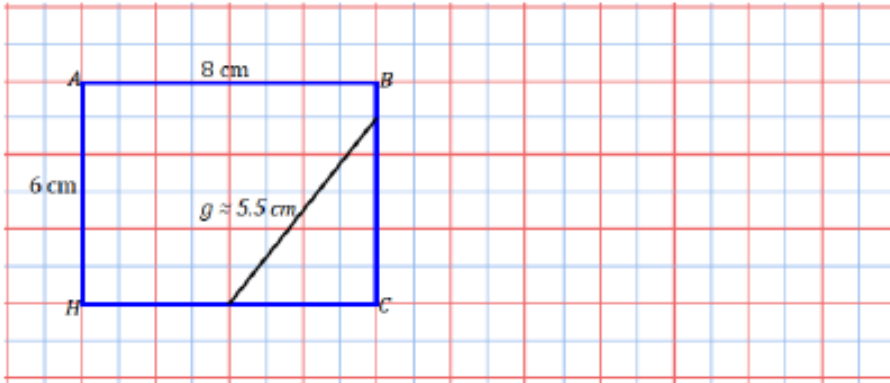

Lesson 17 - Slicing a Right Rectangular Pyramid with a Plane

Essential Questions:

Opening Classwork

RECTANGULAR PYRAMID: Given a rectangular region B in a plane E , and a point V not in E , the rectangular pyramid with base B and vertex V is the collection of all segments VP for any point P in B . It can be shown that the planar region defined by a side of the base B and the vertex V is a triangular region called a *lateral face*.

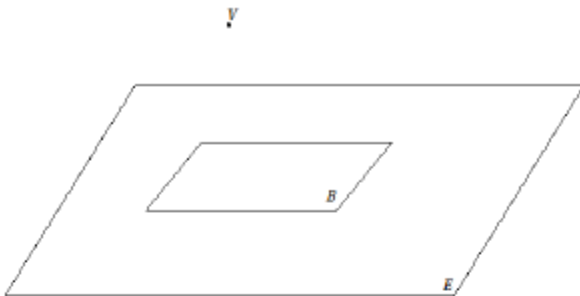

A rectangular region B in a plane E and a point V not in E .

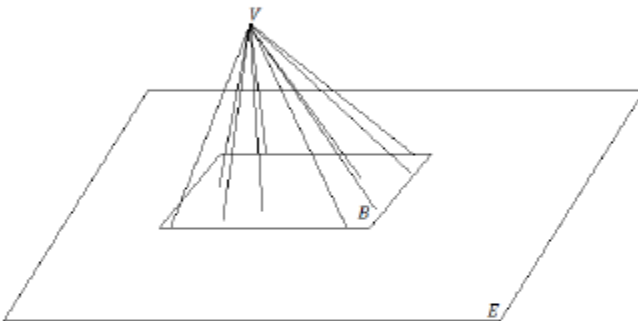

The rectangular pyramid will be determined by the collection of all segments VP for any point P in B ; here V is shown for a total of 10 points.

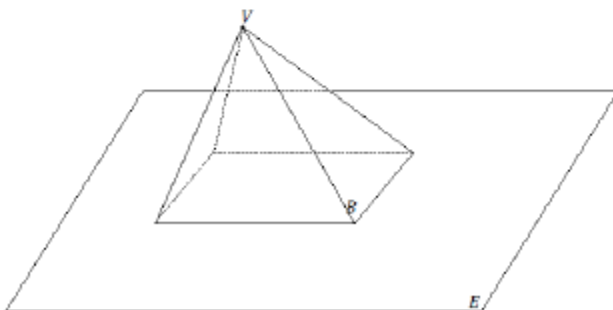

The rectangular pyramid is a solid once the collection of all segments VP for any point P in B are taken. The pyramid has a total of five faces: four lateral faces and a base.

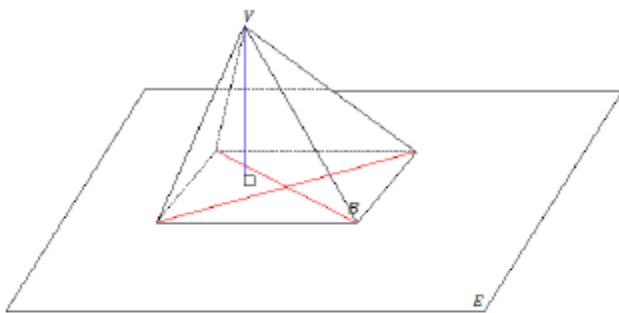

If the vertex lies on the line perpendicular to the base at its center (the intersection of the rectangle's diagonals), the pyramid is called a right rectangular pyramid. The example of the rectangular pyramid above is not a right rectangular pyramid, as evidenced in this image. The perpendicular from V does not meet at the intersection of the diagonals of the rectangular base B.

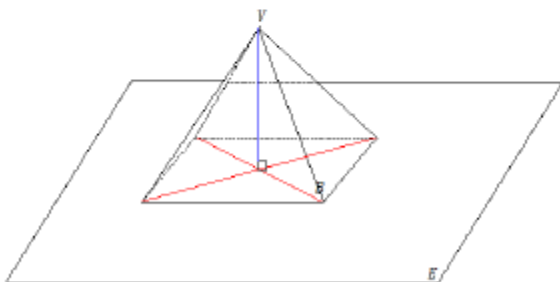

The following is an example of a right rectangular pyramid. The opposite lateral faces are identical isosceles triangles.

Example 1

Use the models you built to assist in a sketch of a pyramid. Though you are sketching from a model that is opaque, use dotted lines to represent the edges that cannot be seen from your perspective.

Eureka Math Module 6 - Geometry

Example 2

Sketch a right rectangular pyramid from three vantage points: (1) from directly over the vertex, (2) from facing straight on to a lateral face, and (3) from the bottom of the pyramid. Explain how each drawing shows each view of the pyramid.

Example 3

Assume the following figure is a top-down view of a rectangular pyramid. Make a reasonable sketch of any two adjacent lateral faces. What measurements must be the same between the two lateral faces? Mark the equal measurement. Justify your reasoning for your choice of equal measurements.

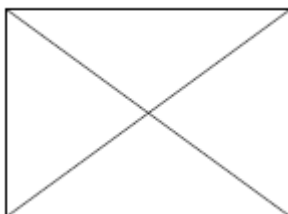

Example 4

- a. A slicing plane passes through segment a parallel to base B of the right rectangular pyramid below. Sketch what the slice will look like into the figure. Then sketch the resulting slice as a two-dimensional figure. Students may choose how to represent the slice (e.g., drawing a 2D or 3D sketch or describing the slice in words).

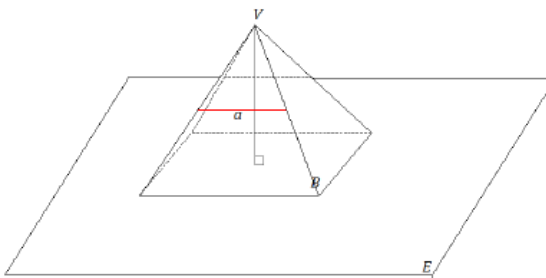

- b. What shape does the slice make? What is the relationship between the slice and the rectangular base of the pyramid?

Eureka Math Module 6 - Geometry

Example 5

A slice is to be made along segment a perpendicular to base B of the right rectangular pyramid below.

- a. Which of the following figures shows the correct slice? Justify why each of the following figures is or is not a correct diagram of the slice.

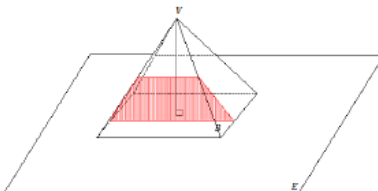
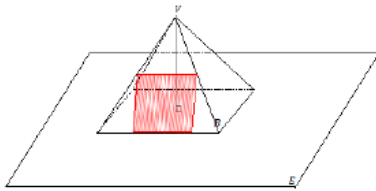
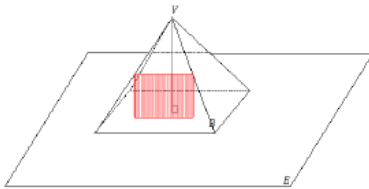
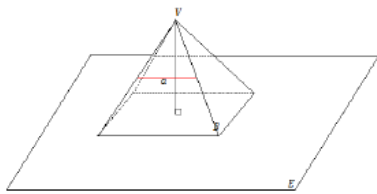

Eureka Math Module 6 - Geometry

- b. A slice is taken through the vertex of the pyramid perpendicular to the base. Sketch what the slice will look like into the figure. Then, sketch the resulting slice itself as a two-dimensional figure.

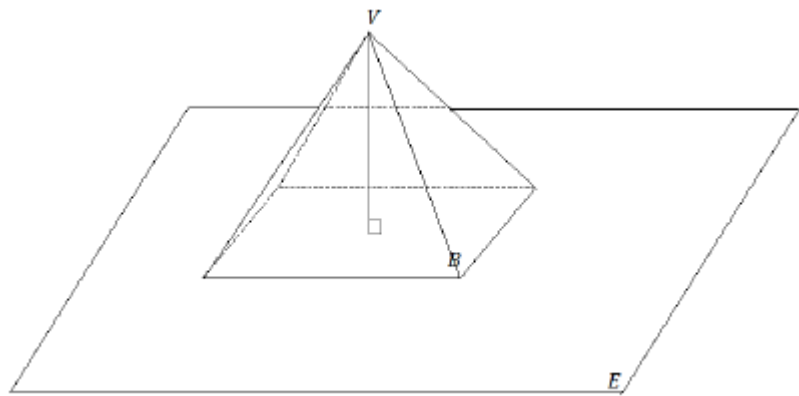

Summary



Lesson 17 - Independent Practice

A side view of a right rectangular pyramid is given. The line segments lie in the lateral faces.

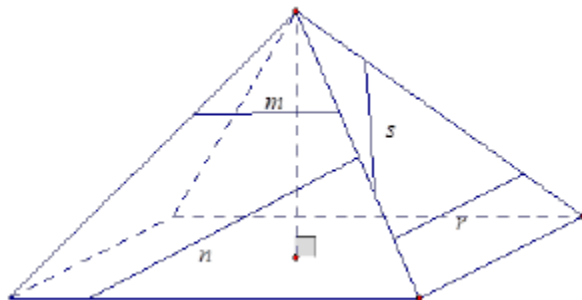

- For segments n , s , and r , sketch the resulting slice from slicing the right rectangular pyramid with a slicing plane that contains the line segment and is perpendicular to the base.

- For segment m , sketch the resulting slice from slicing the right rectangular pyramid with a slicing plane that contains the segment and is parallel to the base.

Note: To challenge yourself, you can try drawing the slice into the pyramid.

Eureka Math Module 6 - Geometry

- c. A top view of a right rectangular pyramid is given. The line segments lie in the base face. For each line segment, sketch the slice that results from slicing the right rectangular pyramid with a plane that contains the line segment and is perpendicular to the base.

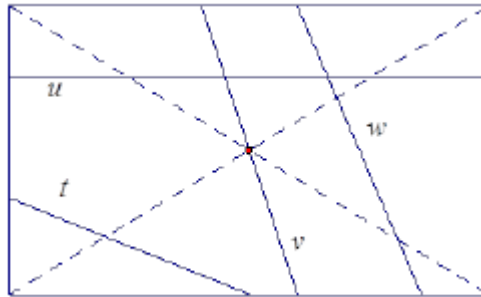

Lesson 18 - Slicing on an Angle

Essential Questions:

Example 1

With your group, discuss whether a right rectangular prism can be sliced at an angle so that the resulting slice looks like the figure in Figure 1. If it is possible, draw an example of such a slice into the following prism.

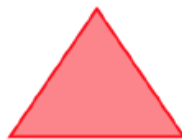
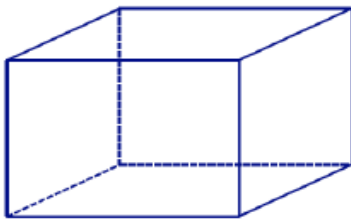

Figure 1

Exercise 1

a. With your group, discuss how to slice a right rectangular prism so that the resulting slice looks like the figure in Figure 2. Justify your reasoning.

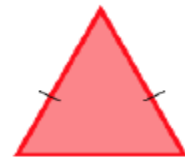

Figure 2

b. With your group, discuss how to slice a right rectangular prism so that the resulting slice looks like the figure in Figure 3. Justify your reasoning.

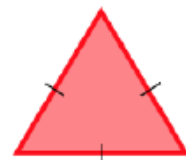

Figure 3

Example 2

With your group, discuss whether a right rectangular prism can be sliced at an angle so that the resulting slice looks like the figure in Figure 4. If it is possible, draw an example of such a slice into the following prism.

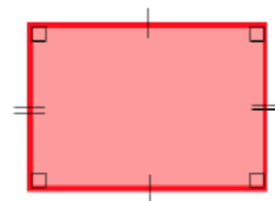
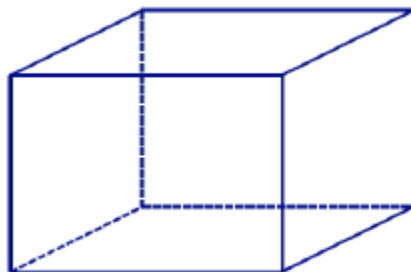
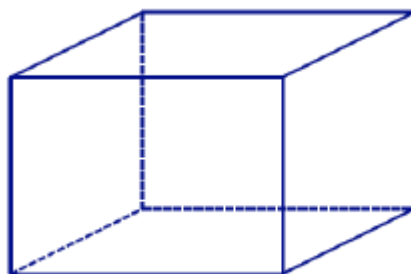

Figure 4

Exercise 2

In Example 2, we discovered how to slice a right rectangular prism to make the shapes of a rectangle and a parallelogram. Are there other ways to slice a right rectangular prism that result in other quadrilateral-shaped slices?



Example 3

- a. If slicing a plane through a right rectangular prism so that the slice meets the three faces of the prism, the resulting slice is in the shape of a triangle; if the slice meets four faces, the resulting slice is in the shape of a quadrilateral. Is it possible to slice the prism in a way that the region formed is a pentagon (as in Figure 5)? A hexagon (as in Figure 6)? An octagon (as in Figure 7)?



Figure 5



Figure 6



Figure 7

- b. Draw an example of a slice in a pentagon shape and a slice in a hexagon shape.

Example 4

- a. With your group, discuss whether a right rectangular pyramid can be sliced at an angle so that the resulting slice looks like the figure in Figure 8. If it is possible, draw an example of such a slice into the following pyramid.

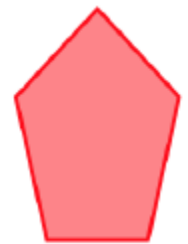
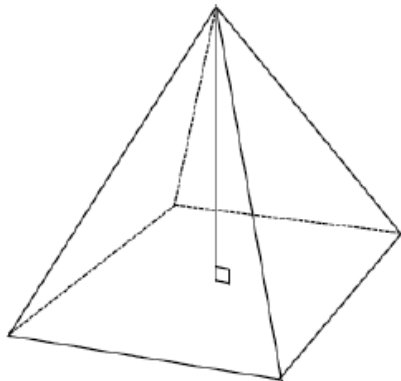

Figure 8

Eureka Math Module 6 - Geometry

- b. With your group, discuss whether a right rectangular pyramid can be sliced at an angle so that the resulting slice looks like the figure in Figure 9. If it is possible, draw an example of such a slice into the pyramid above.



Figure 9

Summary



Lesson 18 - Independent Practice

1. Draw a slice into the right rectangular prism at an angle in the form of the provided shape, and draw each slice as a 2D shape.

Slice made in the prism

Slice as a 2D shape

- a. A triangle

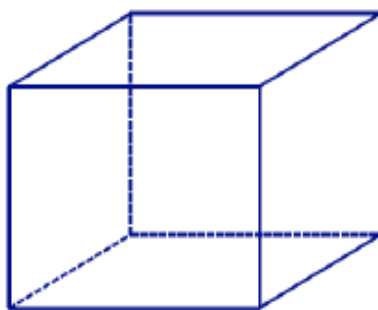

- b. A quadrilateral

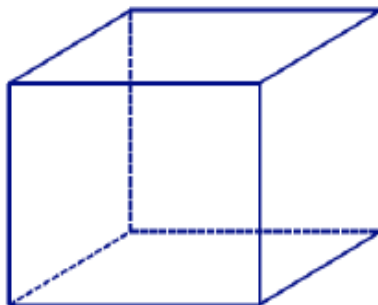

- c. A pentagon

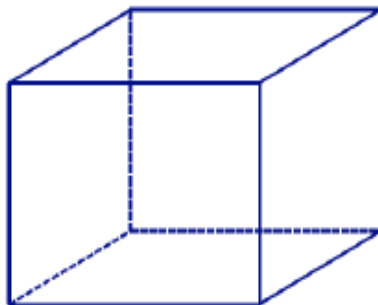

- d. A hexagon

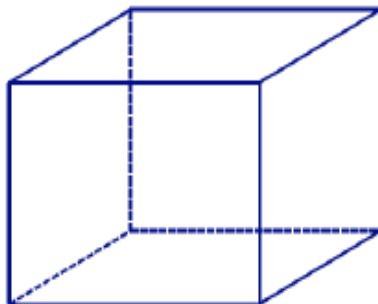

Eureka Math Module 6 - Geometry

2. Draw slices at an angle in the form of each given shape into each right rectangular pyramid, and draw each slice as a 2D shape.

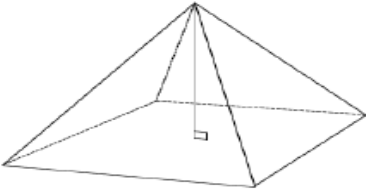
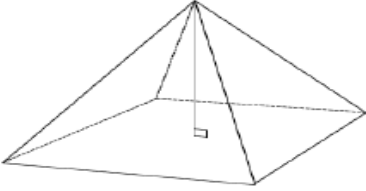
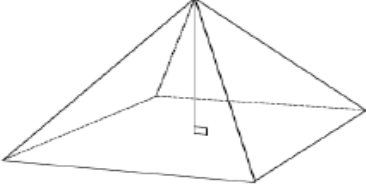
	Slice made in the pyramid	Slice as a 2D shape
a. A triangle		
b. A quadrilateral		
c. A pentagon		

3. Why is it not possible to draw a slice in the shape of a hexagon for a right rectangular pyramid?
4. If the slicing plane meets every face of a right rectangular prism, then the slice is a hexagonal region. What can you say about opposite sides of the hexagon?

Eureka Math Module 6 - Geometry

5. Draw a right rectangular prism so that rectangles $ABCD$ and $A'B'C'D'$ are base faces. The line segments AA' , BB' , CC' , and DD' are edges of the lateral faces.
- a. A slicing plane meets the prism so that vertices A , B , C , and D lie on one side of the plane, and vertices A' , B' , C' , and D' lie on the other side. What other information can be concluded about the slice based on its position?
- b. A slicing plane meets the prism so that vertices A, B, C and B' are on one side of the plane, and vertices A', D', C' , and D' are on the other side. What other information can be concluded about the slice based on its position?

Lesson 19 - Understanding Three-Dimensional Figures

Essential Questions:

Example 1

If slices parallel to the tabletop (with height a whole number of units from the tabletop) were taken of this figure, then what would each slice look like?

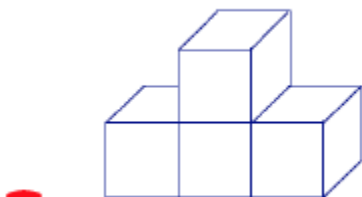

Example 2

If slices parallel to the tabletop were taken of this figure, then what would each slice look like?

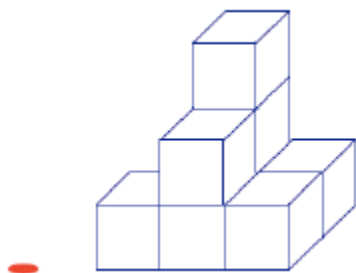

Exercise 1

Based on the level slices you determined in Example 2, how many unit cubes are in the figure?

Exercise 2

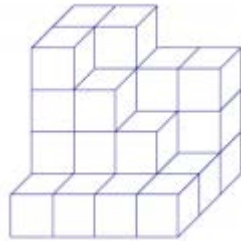

- a. If slices parallel to the tabletop were taken of this figure, then what would each slice look like?

- b. Given the level slices in the figure, how many unit cubes are in the figure?

Example 3

Given the level slices in the figure, how many unit cubes are in the figure?

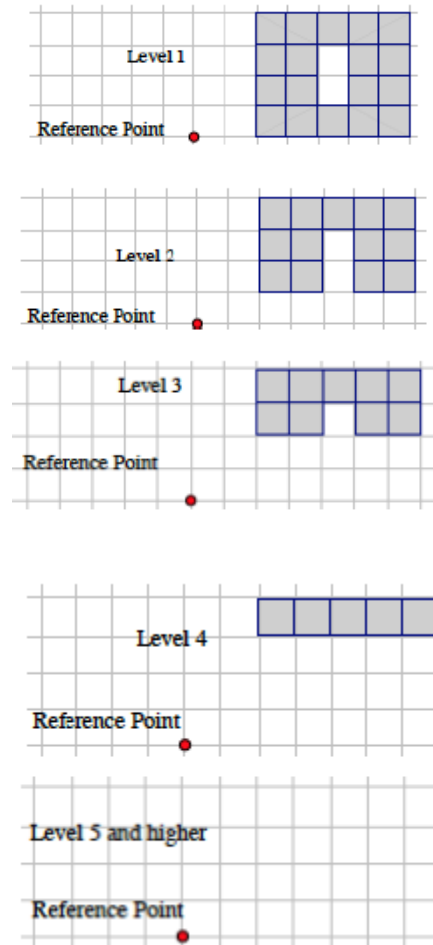

Eureka Math Module 6 - Geometry

Exercise 3

Sketch your own three-dimensional figure made from cubes and the slices of your figure. Explain how the slices relate to the figure.

Summary

Eureka Math Module 6 - Geometry



Lesson 19 - Independent Practice

1. In the given three-dimensional figures, unit cubes are stacked exactly on top of each other on a tabletop. Each block is either visible or below a visible block.
 - a. The following three-dimensional figure is built on a tabletop. If slices parallel to the tabletop are taken of this figure, then what would each slice look like?

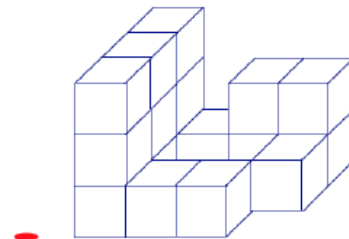

- b. Given the level slices in the figure, how many cubes are in the figure?

Eureka Math Module 6 - Geometry

2.

a. The following three-dimensional figure is built on a tabletop. If slices parallel to the tabletop are taken of this figure, then what would each slice look like?

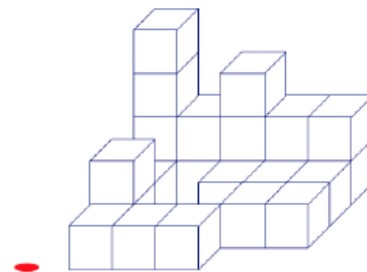

b. Given the level slices in the figure, how many cubes are in the figure?

3.

a. The following three-dimensional figure is built on a tabletop. If slices parallel to the tabletop are taken of this figure, then what would each slice look like?

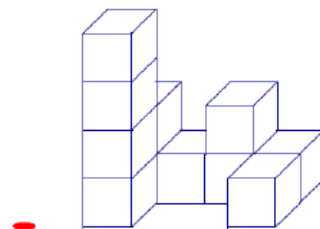

b. Given the level slices in the figure, how many cubes are in the figure?

Eureka Math Module 6 - Geometry

4. John says that we should be including the Level 0 slice when mapping slices. Naya disagrees, saying it is correct to start counting cubes from the Level 1 slice. Who is right?

5. Draw a three-dimensional figure made from cubes so that each successive layer farther away from the tabletop has one less cube than the layer below it. Use a minimum of three layers. Then draw the slices, and explain the connection between the two.

Lesson 20 - Problems Involving Area and Surface Area

Essential Questions:

Opening Exercise

Find the area of each shape based on the provided measurements. Explain how you found each area.

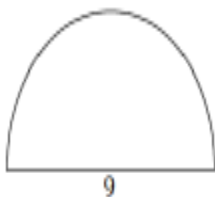
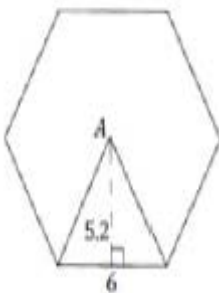
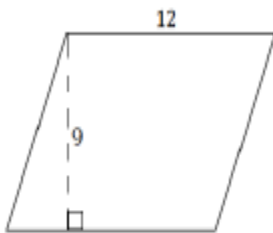
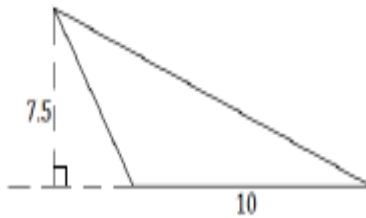

Example 1

A landscape company wants to plant lawn seed. A 20 lb. bag of lawn seed will cover up to 420 sq. ft. of grass and costs \$49.98 plus the 8% sales tax. A scale drawing of a rectangular yard is given. The length of the longest side is 100 ft. The house, driveway, sidewalk, garden areas, and utility pad are shaded. The unshaded area has been prepared for planting grass. How many 20 lb. bags of lawn seed should be ordered, and what is the cost?

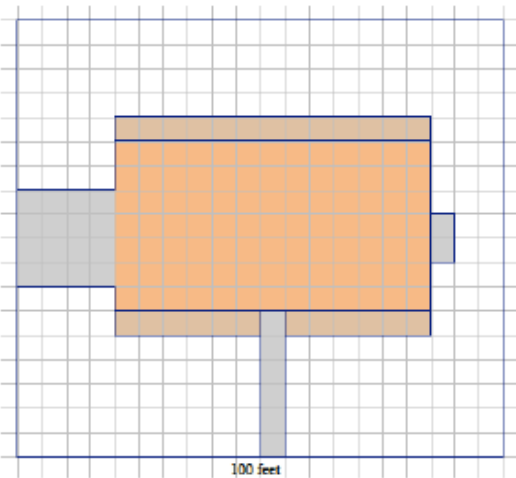

Exercise 1

A landscape contractor looks at a scale drawing of a yard and estimates that the area of the home and garage is the same as the area of a rectangle that is 100 ft. \times 35 ft. The contractor comes up with 5,500 ft². How close is this estimate?

Example 2

Ten dartboard targets are being painted as shown in the following figure. The radius of the smallest circle is 3 in. and each successive larger circle is 3 in. more in radius than the circle before it. A can of red and of white paint is purchased to paint the target. Each 8 oz. can of paint covers 16 ft². Is there enough paint of each color to create all ten targets?



Summary

Eureka Math Module 6 - Geometry



Lesson 20 - Independent Practice

1. A farmer has four pieces of unfenced land as shown to the right in the scale drawing where the dimensions of one side are given. The farmer trades all of the land and \$10,000 for 8 acres of similar land that is fenced. If one acre is equal to 43,560 ft², how much per square foot for the extra land did the farmer pay rounded to the nearest cent?

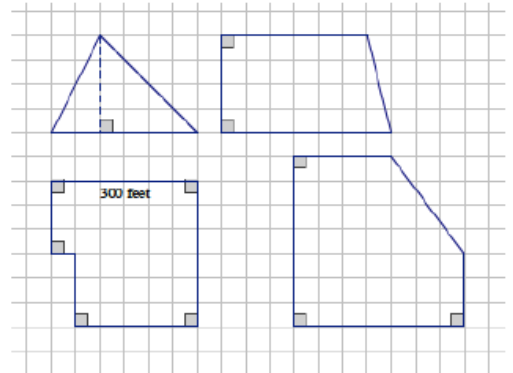

2. An ordinance was passed that required farmers to put a fence around their property. The least expensive fences cost \$10 for each foot. Did the farmer save money by moving the farm?

Eureka Math Module 6 - Geometry

3. A stop sign is an octagon (i.e., a polygon with eight sides) with eight equal sides and eight equal angles. The dimensions of the octagon are given. One side of the stop sign is to be painted red. If Timmy has enough paint to cover 500 ft², can he paint 100 stop signs? Explain your answer.

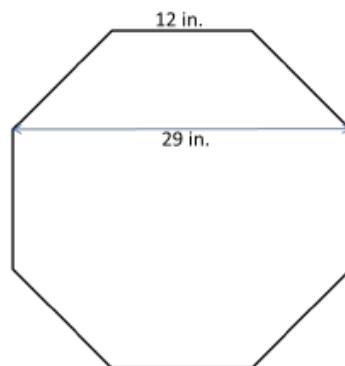

Eureka Math Module 6 - Geometry

4. The Smith family is renovating a few aspects of their home. The following diagram is of a new kitchen countertop. Approximately how many square feet of counter space is there?

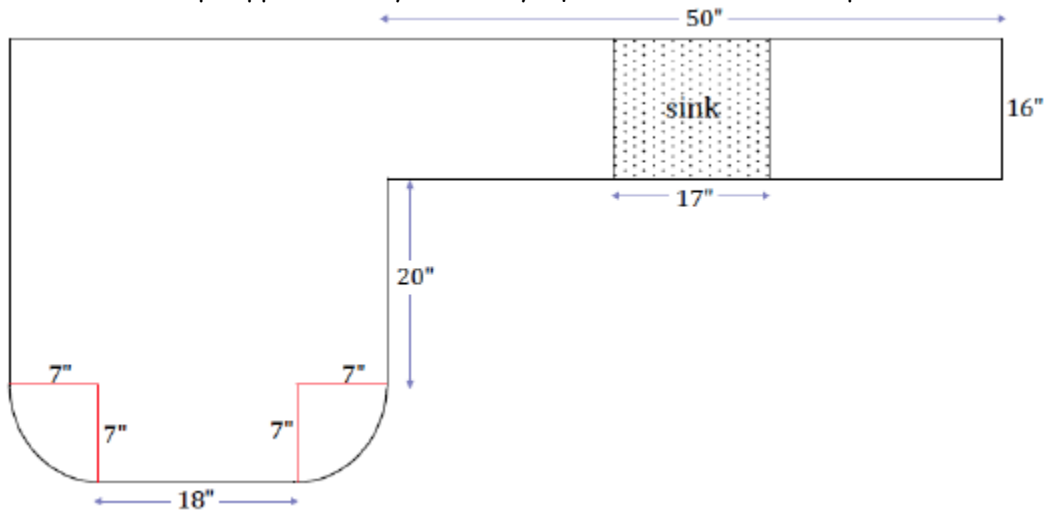

Eureka Math Module 6 - Geometry

5. In addition to the kitchen renovation, the Smiths are laying down new carpet. Everything but closets, bathrooms, and the kitchen will have new carpet. How much carpeting must be purchased for the home?

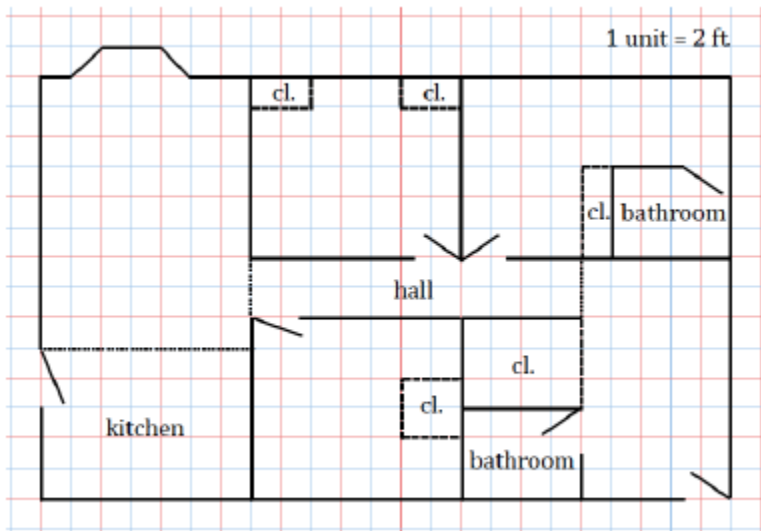

6. Jamie wants to wrap a rectangular sheet of paper completely around cans that are 8 6 in. high and 4 in. in diameter. She can buy a roll of paper that is $8\frac{1}{2}$ in. wide and 60 ft. long. How many cans will this much paper wrap?

Lesson 21 - Mathematical Area Problems

Essential Questions:

Opening Exercise

Patty is interested in expanding her backyard garden. Currently, the garden plot has a length of 4 ft. and a width of 3 ft.

a. What is the current area of the garden?

Patty plans on extending the length of the plot by 3 ft. and the width by 2 ft.

b. What will the new dimensions of the garden be? What will the new area of the garden be?

c. Draw a diagram that shows the change in dimension and area of Patty's garden as she expands it. The diagram should show the original garden as well as the expanded garden.

d. Based on your diagram, can the area of the garden be found in a way other than by multiplying the length by the width?

Eureka Math Module 6 - Geometry

e. Based on your diagram, how would the area of the original garden change if only the length increased by 3 ft.? By how much would the area increase?

f. How would the area of the original garden change if only the width increased by 2 ft.? By how much would the area increase?

g. Complete the following table with the numeric expression, area, and increase in area for each change in the dimensions of the garden.

Dimensions of the garden	Numeric expression for the area of the garden	Area of the garden	Increase in area of the garden
Original garden with length of 4 ft. and width of 3 ft.			
The original garden with length extended by 3 ft. and width extended by 2 ft.			
The original garden with only the length extended by 3 ft.			
The original garden with only the width extended by 2 ft.			

Eureka Math Module 6 - Geometry

- h. Will the increase in both the length and width by 3 ft. and 2 ft., respectively, mean that the original area will increase strictly by the areas found in parts (e) and (f)? If the area is increasing by more than the areas found in parts (e) and (f), explain what accounts for the additional increase.

Example 1

Examine the change in dimension and area of the following square as it increases by 2 units from a side length of 4 units to a new side length of 6 units. Observe the way the area is calculated for the new square. The lengths are given in units, and the areas of the rectangles and squares are given in units²

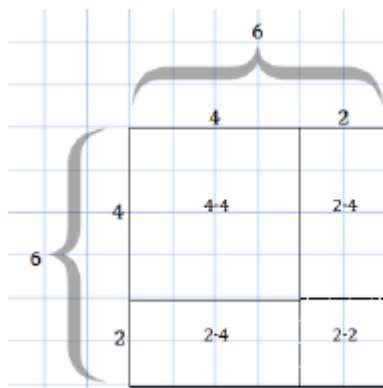

- a. Based on the example above, draw a diagram for a square with a side length of 3 units that is increasing by 2 units. Show the area calculation for the larger square in the same way as in the example.

- b. Draw a diagram for a square with a side length of 5 units that is increased by 3 units. Show the area calculation for the larger square in the same way as in the example.

Eureka Math Module 6 - Geometry

c. Generalize the pattern for the area calculation of a square that has an increase in dimension. Let the side length of the original square be a units and the increase in length be by b units to the length and width. Use the diagram below to guide your work.

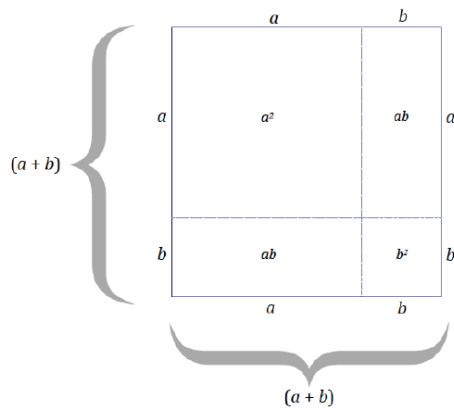

Example 2

Bobby draws a square that is 10 units by 10 units. He increases the length by xx units and the width by 2 units.

a. Draw a diagram that models this scenario.

b. Assume the area of the large rectangle is 156 units². Find the value of x .

Eureka Math Module 6 - Geometry

Example 3

The dimensions of a square with a side length of x units are increased. In this figure, the indicated lengths are given in units, and the indicated areas are given in units².

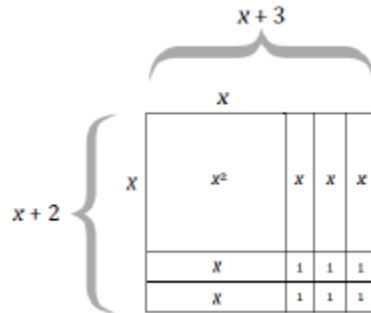

What are the dimensions of the large rectangle in the figure?	
Use the expressions in your response from part (a) to write an equation for the area of the large rectangle, where A represents area.	
Use the areas of the sections within the diagram to express the area of the large rectangle.	
What can be concluded from parts (b) and (c)?	
Explain how the expressions $(x + 2)(x + 3)$ & $x^2 + 3x + 2x + 6$ differ within the context of the area of the figure.	

Summary

Eureka Math Module 6 - Geometry



Lesson 21 - Independent Practice

1. A square with side length a units is decreased by b units in both length and width.

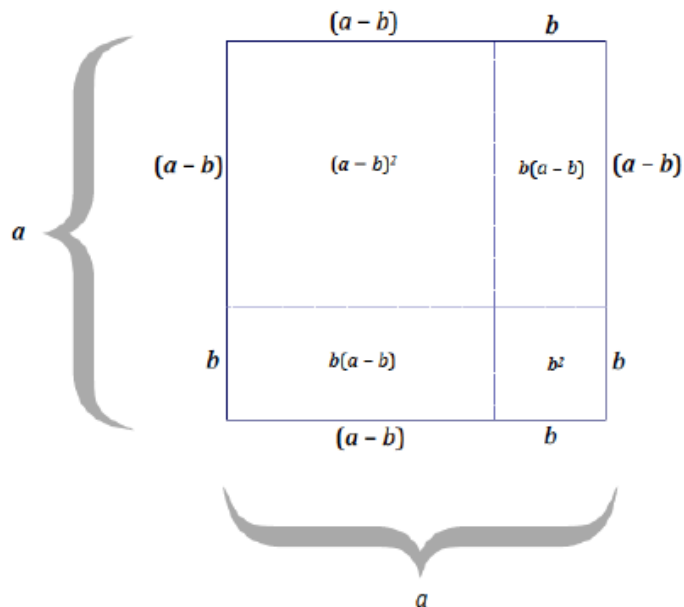

Use the diagram to express $(a - b)^2$ in terms of the other a^2 , ab , and b^2 by filling in the blanks below:

$$\begin{aligned}
 (a - b)^2 &= a^2 - b(a - b) - b(a - b) - b^2 \\
 &= a^2 - \underline{\quad} + \underline{\quad} - \underline{\quad} + \underline{\quad} - b^2 \\
 &= a^2 - 2ab + \underline{\quad} - b^2 \\
 &= \underline{\hspace{2cm}}
 \end{aligned}$$

Eureka Math Module 6 - Geometry

2. In Example 3, part (c), we generalized that $(a + b)^2 = a^2 + 2ab + b^2$. Use these results to evaluate the following expressions by writing $1001 = 1000 + 1$, etc.
- Evaluate 100^2 .
 - Evaluate 1001^2 .
 - Evaluate 21^2 .
3. Use the results of Problem 1 to evaluate 999^2 by writing $999 = 1000 - 1$.

Eureka Math Module 6 - Geometry

4. The figures below show that $8^2 - 5^2$ is equal to $(8 - 5)(8 + 5)$.

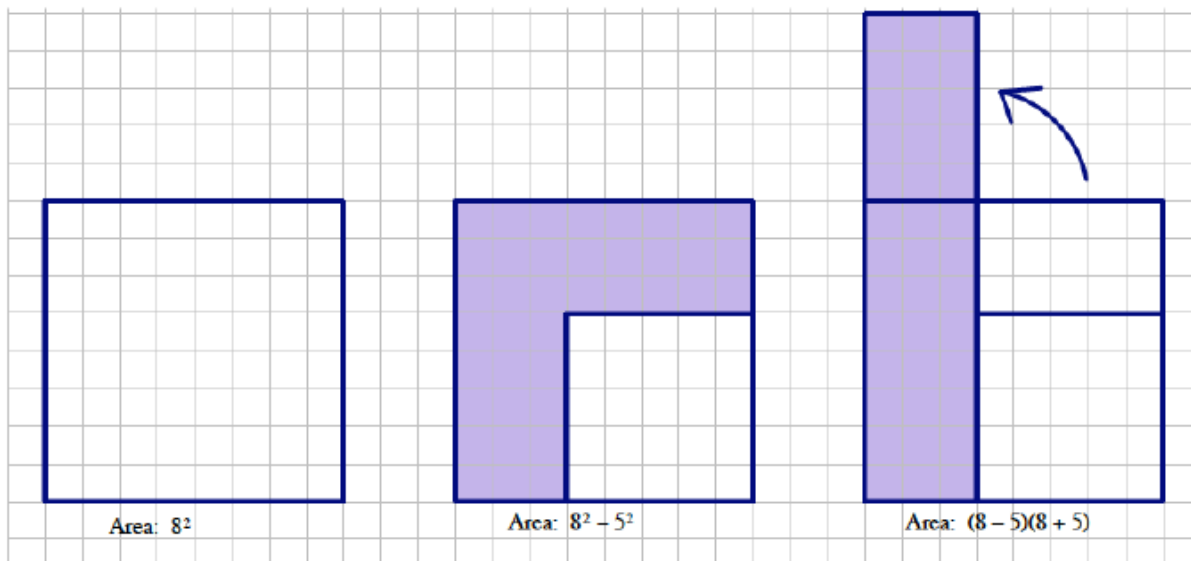

- a. Create a drawing to show $a^2 - b^2 = (a - b)(a + b)$.
- b. Use the result in part (a), $a^2 - b^2 = (a - b)(a + b)$, to explain why:
- $35^2 - 5^2 = (30)(40)$
 - $21^2 - 18^2 = (3)(39)$
 - $104^2 - 63^2 = (41)(167)$
- c. Use the fact that $35^2 = (30)(40) + 5^2 = 1225$ to create a way to mentally square any two digit number ending in 5.

Eureka Math Module 6 - Geometry

5. Create an area model for each product. Use the area model to write an equivalent expression that represents the area.

a. $(x+1)(x+4) = x^2 + x + 4x + 4$

b. $(x + 5)(x + 2) = x^2 + 5x + 2x + 10$

- c. Based on the context of the area model, how do the expressions provided in parts (a) and (b) differ from the equivalent expression answers you found for each?

6. Use the distributive property to multiply the following expressions.

a. $(2 + 6)(2 + 4)$

b. $(x + 6)(x + 4)$; draw a figure that models this multiplication problem.

c. $(10 + 7)(10 + 7)$

Eureka Math Module 6 - Geometry

d. $(a + 7)(a + 7)$

e. $(5 - 3)(5 + 3)$

f. $(x - 3)(x + 3)$

Lesson 22 - Area Problems with Circular Regions

Essential Questions:

Example 1

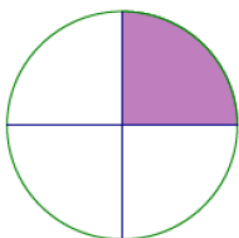

a. The circle above has a diameter of 12 cm. Calculate the area of the shaded region.

b. Sasha, Barry, and Kyra wrote three different expressions for the area of the shaded region. Describe what each student was thinking about the problem based on their expression.

Sasha's expression: $\frac{1}{4}\pi(6^2)$

Barry's expression: $\pi(6^2) - \frac{3}{4}\pi(6^2)$

Kyra's expression: $\frac{1}{2}(\frac{1}{2}\pi(6^2))$

Eureka Math Module 6 - Geometry

Exercise 1



Find the area of the shaded region of the circle to the above.

Explain how the expression you used represents the area of the shaded region.

Exercise 2

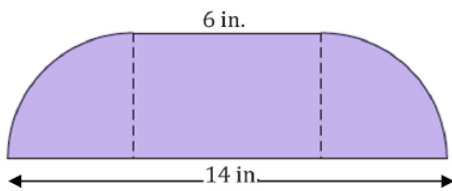

Calculate the area of the figure above that consists of a rectangle and two quarter circles, each with the same radius. Leave your answer in terms of pi.

Eureka Math Module 6 - Geometry

Example 2

The square in this figure has a side length of 14 inches. The radius of the quarter circle is 7 inches.

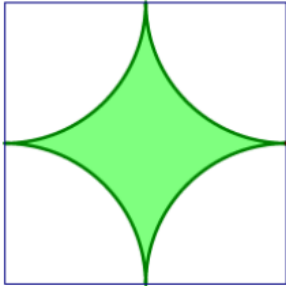

14 inches

Estimate the shaded area.

What is the exact area of the shaded region?

What is the approximate area using : $\pi \approx \frac{22}{7}$

Eureka Math Module 6 - Geometry

Exercise 3

The vertices of A and B of rectangle $ABCD$ are centers of circles each with a radius of 5 inches.

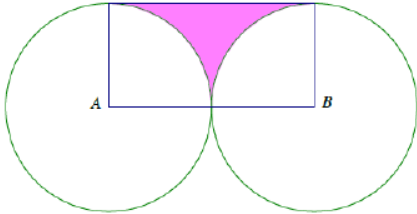

Find the exact area of the shaded region.

What is the approximate area using : $\pi \approx \frac{22}{7}$

Find the area to the nearest hundredth using the π key on your calculator.

Exercise 4

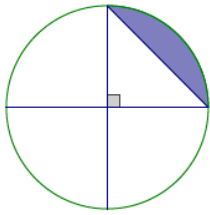

The diameter of the circle is 12 in. Write and explain a numerical expression that represents the area of the shaded region.

Summary

Eureka Math Module 6 - Geometry



Lesson 22 - Independent Practice

1. A circle with center O has an area of 96 in^2 . Find the area of the shaded region.



Peyton's Solution

$$A = \frac{1}{3}(96) \text{ in}^2 = 32 \text{ in}^2$$

Monte's Solution

$$A = \frac{96}{120} \text{ in}^2 = 0.8 \text{ in}^2$$

Which person solved the problem correctly? Explain your reasoning.

2. The following region is bounded by the arcs of two quarter circles each with a radius of 4 cm and by line segments 6 cm in length. The region on the right shows a rectangle with dimensions 4 cm by 6 cm. Show that both shaded regions have equal areas.

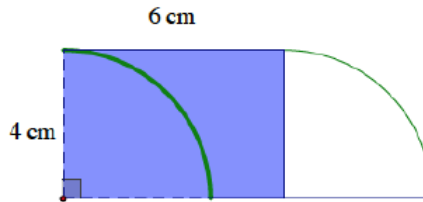
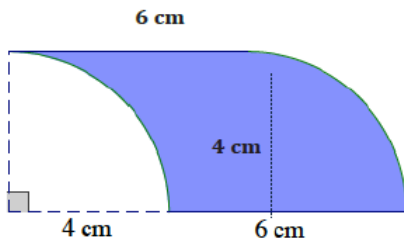

3. A square is inscribed in a paper disc (i.e., a circular piece of paper) with a radius of 8 cm. The paper disc is red on the front and white on the back. Two edges of the square are folded over. Write and explain a numerical expression that represents the area of the figure. Then, find the area of the figure.

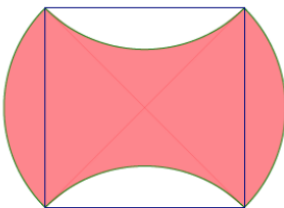

Eureka Math Module 6 - Geometry

4. The diameters of four half circles are sides of a square with a side length of 7 cm.

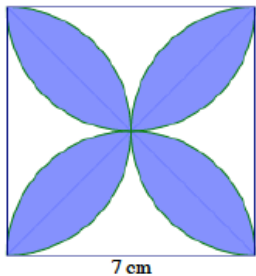

- Find the exact area of the shaded region.
 - What is the approximate area using $\pi \approx \frac{22}{7}$
 - Find the area using the π button on your calculator and rounding to the nearest thousandth.
5. A square with a side length of 14 inches is shown below, along with a quarter circle (with a side of the square as its radius) and two half circles (with diameters that are sides of the square). Write and explain a numerical expression that represents the area of the figure.

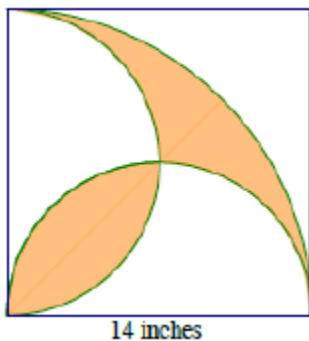

Eureka Math Module 6 - Geometry

6. Three circles have centers on segment AB . The diameters of the circles are in the ratio $3:2:1$. If the area of the largest circle is 36 ft^2 , find the area inside the largest circle but outside the smaller two circles.

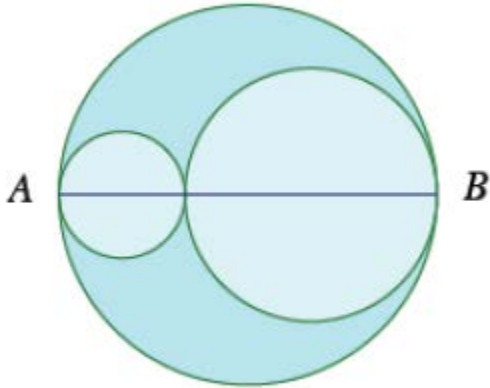

7. Three circles have centers on segment AB . The diameters of the circles are in the ratio $3:2:1$. If the area of the largest circle is 36 ft^2 , find the area inside the largest circle but outside the smaller two circles.

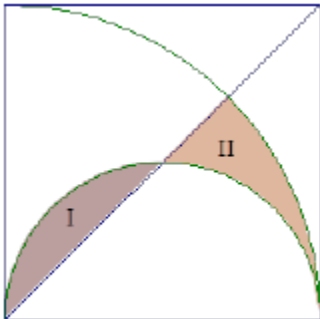

Lesson 23 - Surface Area

Essential Questions:

Opening Exercise

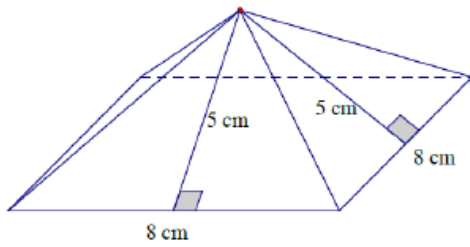

Calculate the surface area of the square pyramid.

Example 1

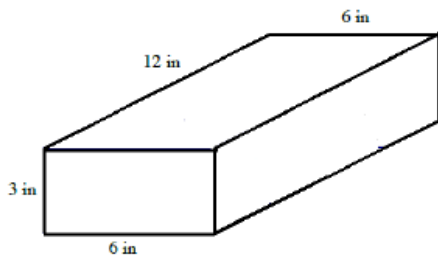

- a. Calculate the surface area of the rectangular prism.

Eureka Math Module 6 - Geometry

- b. Imagine that a piece of the rectangular prism is removed. Determine the surface area of both pieces.

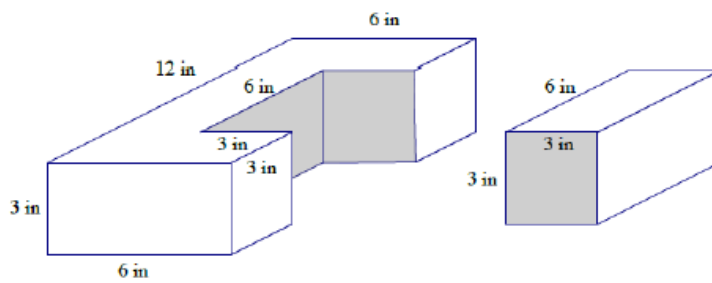

- c. How is the surface area in part (a) related to the surface area in part (b)?

Eureka Math Module 6 - Geometry

Exercise 1-5

Determine the surface area of the right prisms.

1.

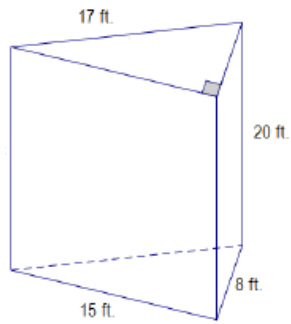

2.

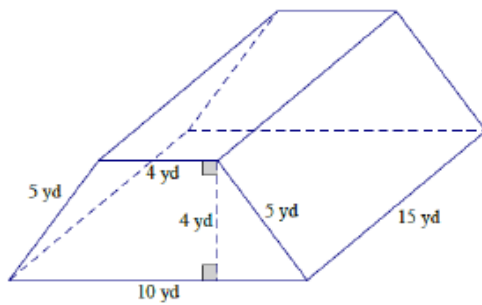

3.

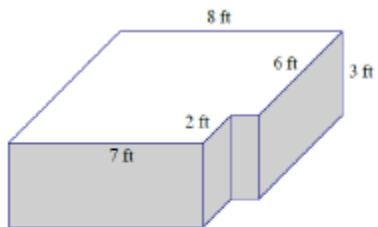

Eureka Math Module 6 - Geometry

4.

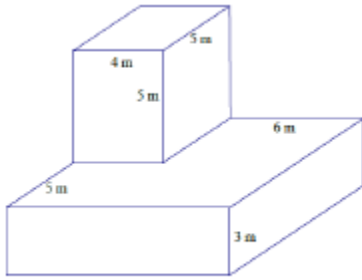

5.

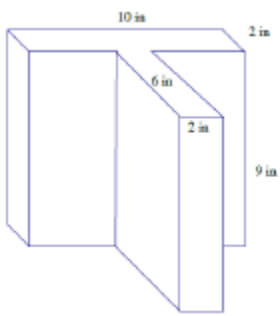

Summary

Eureka Math Module 6 - Geometry



Lesson 23 - Independent Practice

Determine the surface area of the figures.

1.

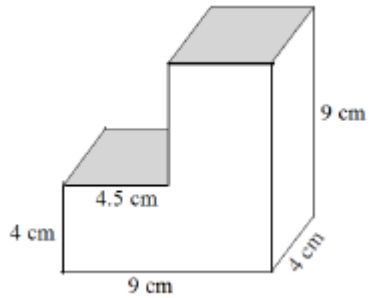

2.

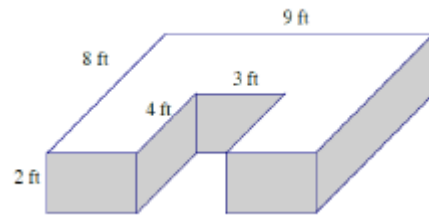

3.

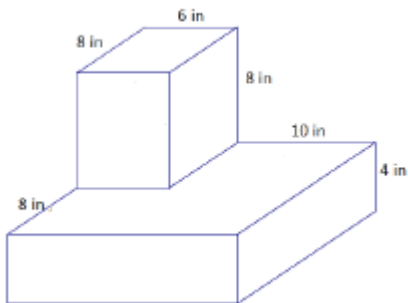

4.

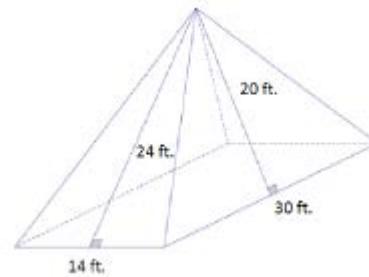

5.

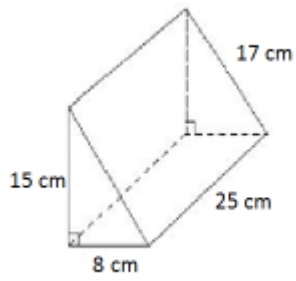

Lesson 24 - Surface Area

Essential Questions:

Example 1

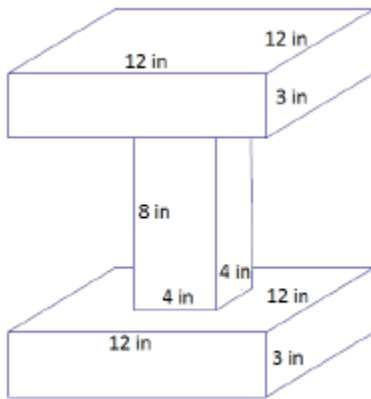

Determine the surface area of the image.

Example 2

Determine the surface area of the cube.

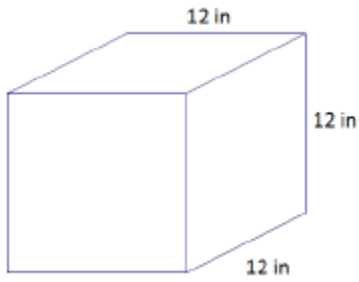

A square hole with a side length of 4 inches is drilled through the cube. Determine the new surface area.

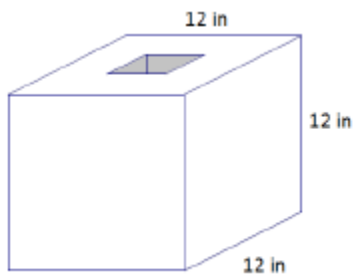

Example 3

A right rectangular pyramid has a square base with a side length of 10 inches. The surface area of the pyramid is 260 in. Find the height of the four lateral triangular faces.

Exercise 1-8

Determine the surface area of each figure. Assume all faces are rectangles unless it is indicated otherwise.

1.

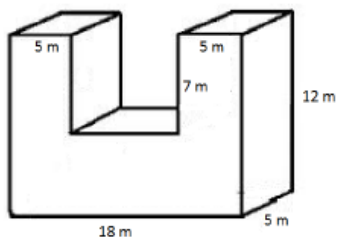

2. In addition to your calculation, explain how the surface area of the following figure was determined.

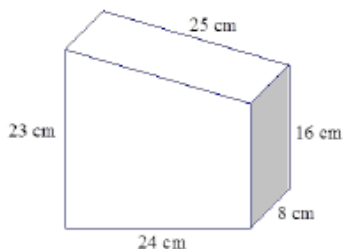

Eureka Math Module 6 - Geometry

3.

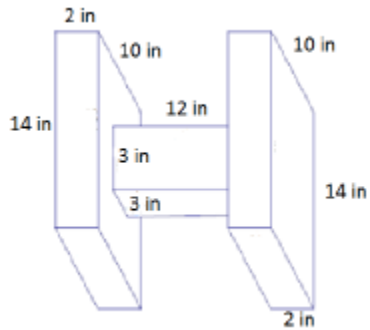

4. In addition to your calculation, explain how the surface area was determined.

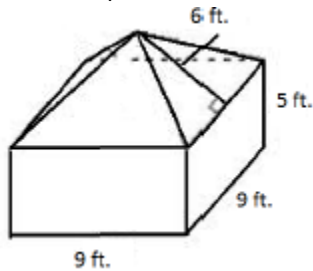

5. A hexagonal prism has the following base and has a height of 8 units. Determine the surface area of the prism.



Eureka Math Module 6 - Geometry

6. Determine the surface area of each figure.

a.

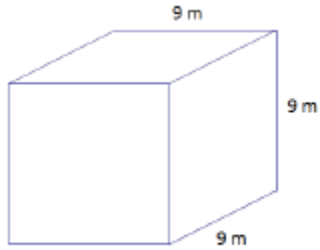

- b. A cube with a square hole with 3 m side lengths has been drilled through the cube.

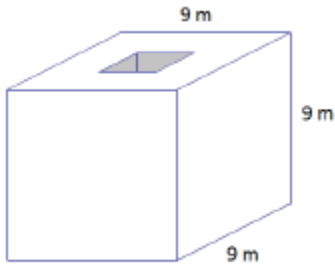

- c. A second square hole with 3 m side lengths has been drilled through the cube.

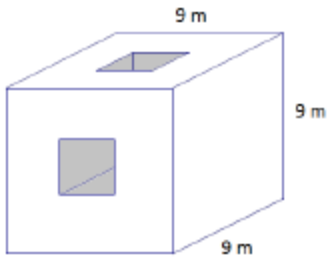

Eureka Math Module 6 - Geometry

7. The figure below shows 28 cubes with an edge length of 1 unit. Determine the

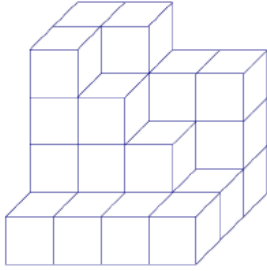

surface area.

8. The base rectangle of a right rectangular prism is 4 ft. \times 6 ft. The surface area is 288 ft². Find the height. Let h be the height in feet.

Summary

Eureka Math Module 6 - Geometry



Lesson 24 - Independent Practice

Determine the surface area of each figure.

1. In addition to the calculation of the surface area, describe how you found the surface area.

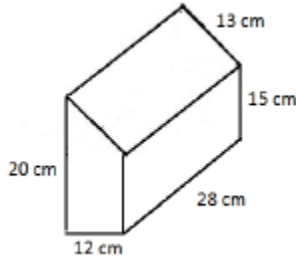

- 2.

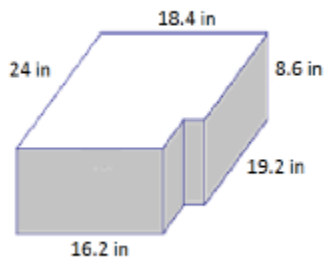

- 3.

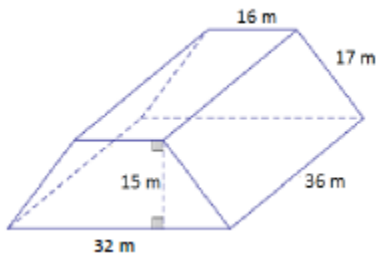

Eureka Math Module 6 - Geometry

4. Determine the surface area after two square holes with a side length of 2 m are drilled through the solid figure composed of two rectangular prisms.

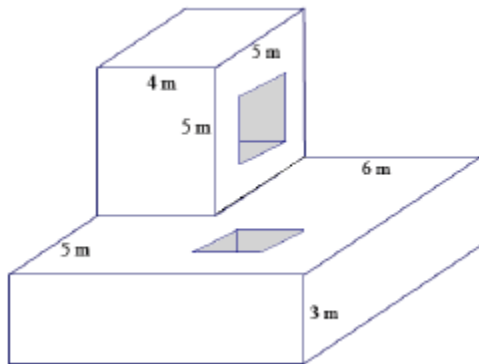

5. The base of a right prism is shown below. Determine the surface area if the height of the prism is 10 cm. Explain how you determined the surface area.

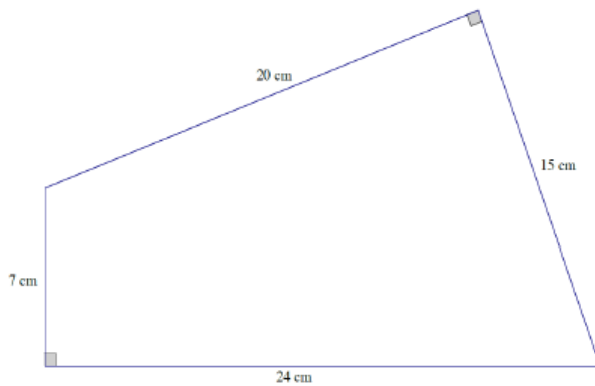

Lesson 25 - Volume of Right Prisms

Essential Questions:

Opening Exercise:

Take your copy of the following figure, and cut it into four pieces along the dotted lines (the vertical line is the altitude, and the horizontal line joins the midpoints of the two sides of the triangle).

Arrange the four pieces so that they fit together to form a rectangle.

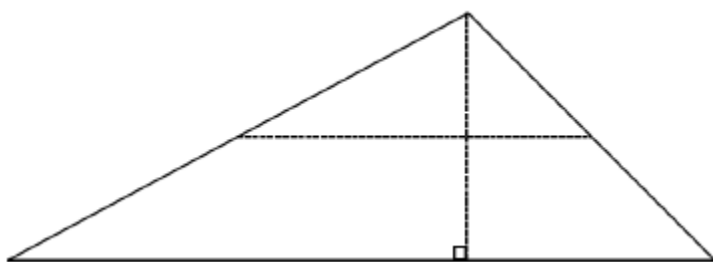

If a prism were formed out of each shape, the original triangle, and your newly rearranged rectangle, and both prisms had the same height, would they have the same volume? Discuss with a partner.

Eureka Math Module 6 - Geometry

Exercise 1

Show that the following figures have equal volumes.

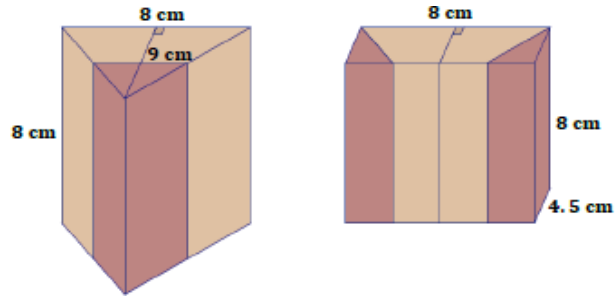

How can it be shown that the prisms will have equal volumes without completing the entire calculation?

Example 1

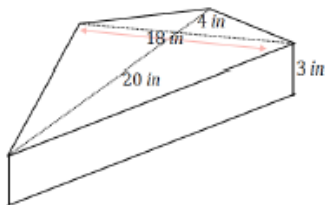

Calculate the volume of the prism.

Example 2

A container is shaped like a right pentagonal prism with an open top. When a cubic foot of water is dumped into the container, the depth of the water is 8 inches. Find the area of the pentagonal base.

Example 3

Two containers are shaped like right triangular prisms, each with the same height. The base area of the larger container is 200% more than the base area of the smaller container. How many times must the smaller container be filled with water and poured into the larger container in order to fill the larger container?

Exercise 2

Two aquariums are shaped like right rectangular prisms. The ratio of the dimensions of the larger aquarium to the dimensions of the smaller aquarium is 3:2.

- Addie says the larger aquarium holds 50% more water than the smaller aquarium.
- Berry says that the larger aquarium holds 150% more water.
- Cathy says that the larger aquarium holds over 200% more water.

Are any of the girls correct?
Explain your reasoning.

Summary

Eureka Math Module 6 - Geometry



Lesson 25 - Independent Practice

1. The pieces in Figure 1 are rearranged and put together to form Figure 2.

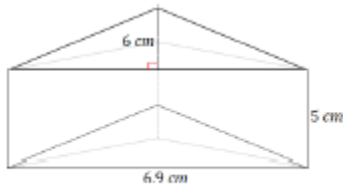

Figure 1

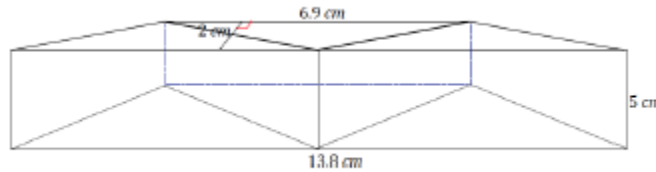

Figure 2

- Use the information in Figure 1 to determine the volume of the prism.
 - Use the information in Figure 2 to determine the volume of the prism.
 - If we were not told that the pieces of Figure 1 were rearranged to create Figure 2, would it be possible to determine whether the volumes of the prisms were equal without completing the entire calculation for each?
2. Each of two right prism containers is filled with 60 gallons of water. The depth of the water in the first container is 20 inches. The depth of the water in the second container is 30 inches. If the area of the base in the first container is 6 ft², find the area of the base in the second container. Explain your reasoning.

Eureka Math Module 6 - Geometry

3. Two containers are shaped like right rectangular prisms. Each has the same height, but the base of the larger container is 50% more in each direction. If the smaller container holds 8 gallons when full, how many gallons does the larger container hold? Explain your reasoning.
4. A right prism container with the base area of 4 ft^2 and height of 5 ft. is filled with water until it is 3 ft. deep. If a solid cube with edge length 1 ft. is dropped to the bottom of the container, how much will the water rise?
5. A right prism container with a base area of 10 ft^2 and height 9 ft. is filled with water until it is 6 ft. deep. A large boulder is dropped to the bottom of the container, and the water rises to the top completely submerging the boulder and without causing overflow. Find the volume of the boulder.
6. A right prism container with a base area of 8 ft^2 and height 6 ft. is filled with water until it is 5 ft. deep. A solid cube is dropped to the bottom of the container, and the water rises to the top. Find the length of the cube.

Eureka Math Module 6 - Geometry

7. A rectangular swimming pool is 30 feet wide and 50 feet long. The rectangular floor of the swimming pool is 30 feet wide, 3 feet deep at one end, and 10 feet deep at the other.
- Sketch the swimming pool as a right prism.
 - What kind of right prism is the swimming pool?
 - What is the volume of the swimming pool in cubic feet?
 - How many gallons will the swimming pool hold if each cubic feet of water is about 7.5 gallons?
8. A milliliter (mL) has a volume of 1 cm^3 . A 250 mL measuring cup is filled to 200 mL. A small stone is placed in the measuring cup. The stone is completely submerged, and the water level rises to 250mL.
- What is the volume of the stone in cm^3 ?
 - Describe a right rectangular prism that has the same volume as the stone.

Lesson 26 - Volume of Composite Three-Dimensional Objects

Essential Questions:

Example 1

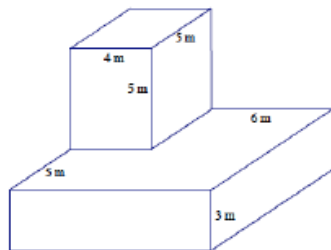

Find the volume of the following three-dimensional object composed of two right rectangular prisms.

Exercise 1

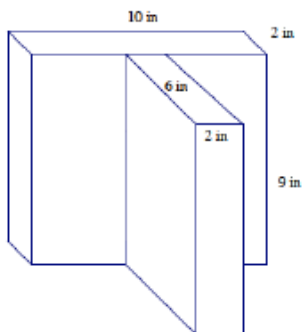

Find the volume of the following three-dimensional figure composed of two right rectangular prisms.

Exercise 2

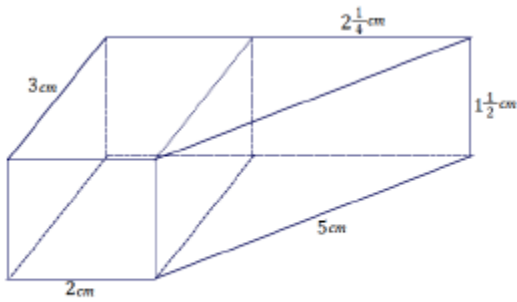

The right trapezoidal prism is composed of a right rectangular prism joined with a right triangular prism. Find the volume of the right trapezoidal prism shown in the diagram using two different strategies.

Example 2

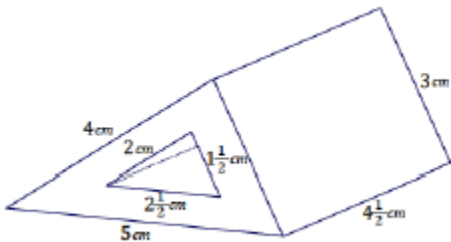

Find the volume of the right prism shown in the diagram whose base is the region between two right triangles. Use two different strategies.

Eureka Math Module 6 - Geometry

Example 3

A box with a length of 2 ft., a width of 1.5 ft., and a height of 1.25 ft. contains fragile electronic equipment that is packed inside a larger box with three inches of styrofoam cushioning material on each side (above, below, left side, right side, front, and back).

a. Give the dimensions of the larger box.	
b. Design styrofoam right rectangular prisms that could be placed around the box to provide the cushioning (i.e., give the dimensions and how many of each size are needed).	
c. Find the volume of the styrofoam cushioning material by adding the volumes of the right rectangular prisms in the previous question.	
d. Find the volume of the styrofoam cushioning material by computing the difference between the volume of the larger box and the volume of the smaller box.	

Summary

Eureka Math Module 6 - Geometry



Lesson 26 - Independent Practice

1. Find the volume of the three-dimensional object composed of right rectangular prisms.

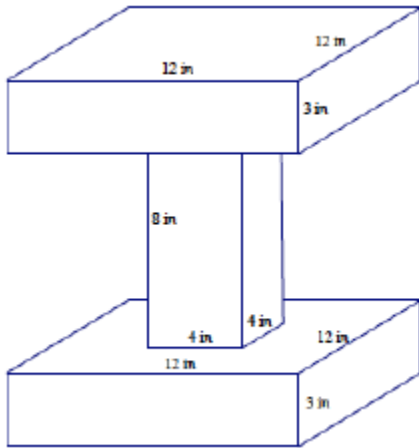

2. A smaller cube is stacked on top of a larger cube. An edge of the smaller cube measures $\frac{1}{2}$ cm in length, while the larger cube has an edge length three times as long. What is the total volume of the object?

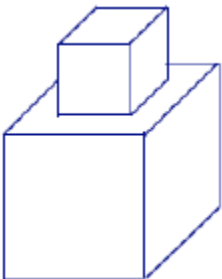

3. Two students are finding the volume of a prism with a rhombus base but are provided different information regarding the prism. One student receives Figure 1, while the other receives Figure

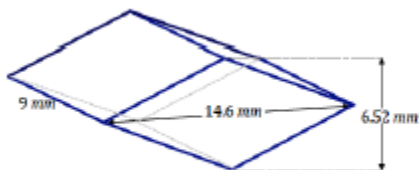

Figure 1

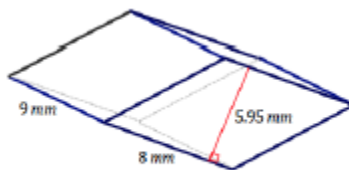
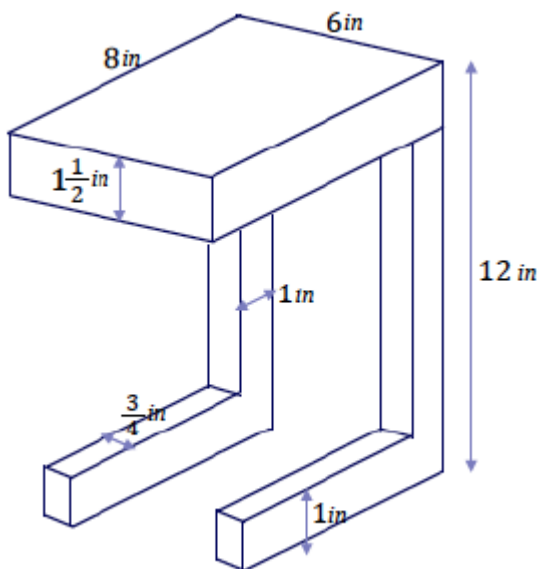

Figure 2

- a. Find the expression that represents the volume in each case; show that the volumes are equal.

Eureka Math Module 6 - Geometry

- b. How does each calculation differ in the context of how the prism is viewed?
4. Find the volume of wood needed to construct the following side table composed of right rectangular prisms.



5. A plastic die (singular for dice) of a game has an edge length of 1.5 cm. Each face of the cube has the number of cubic cutouts as its marker is supposed to indicate (i.e., the face marked 3 has 3 cutouts). What is the volume of the die?

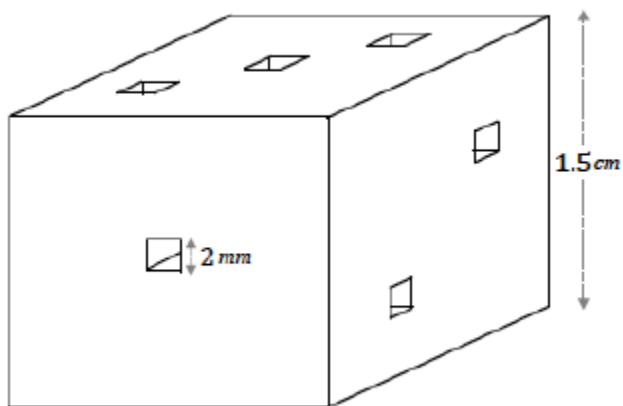

Eureka Math Module 6 - Geometry

6. A wooden cube with edge length 6 inches has square holes (holes in the shape of right rectangular prisms) cut through the centers of each of the three sides as shown in the figure. Find the volume of the resulting solid if the square for the holes has an edge length of 1 inch.

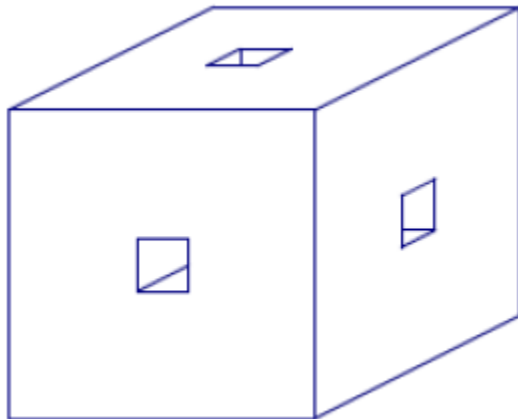

7. A right rectangular prism has each of its dimensions (length, width, and height) increased by 50%. By what percent is its volume increased?
8. A solid is created by putting together right rectangular prisms. If each of the side lengths is increase by 40%, by what percent is the volume increased?

Lesson 27- Real World Volume Problems

Essential Questions:

Example 1

A swimming pool holds 10,000 ft³ of water when filled. Jon and Anne want to fill the pool with a garden hose. The garden hose can fill a five-gallon bucket in 30 seconds. If each cubic foot is about 7.5 gallons, find the flow rate of the garden hose in gallons per minute and in cubic feet per minute. About how long will it take to fill the pool with a garden hose? If the hose is turned on Monday morning at 8:00 a.m., approximately when will the pool be filled?

Example 2

A square pipe (a rectangular prism-shaped pipe) with inside dimensions of 2 in. x 2 in. has water flowing through it at the speed of 3 ft/s. The water flows into a pool in the shape of a right triangular prism, with a base in the shape of a right isosceles triangle and with legs that are each 5 feet in length. How long will it take for the water to reach a depth of 4 feet?

Exercise 1

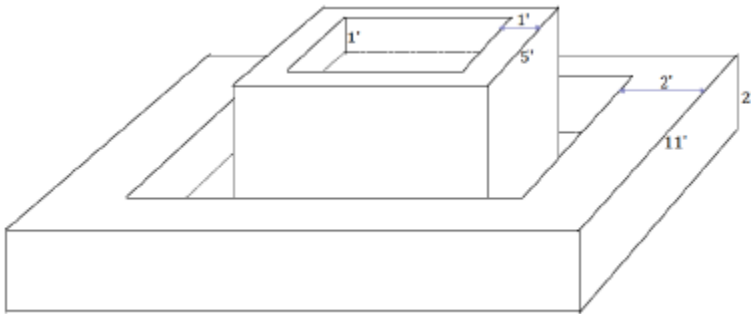

A park fountain is about to be turned on in the spring after having been off all winter long. The fountain flows out of the top level and into the bottom level until both are full, at which point the water is just recycled from top to bottom through an internal pipe. The outer wall of the top level, a right square prism, is five feet in length, the thickness of the stone between outer and inner wall is 1 ft., and the depth is 1 ft. The bottom level, also a right square prism, has an outer wall that is 11 ft. long with a 2 ft. thickness between the outer and inner wall and a depth of 2 ft. Water flows through a 3 in. \times 3 in. square pipe into the top level of the fountain at a rate of 4 ft/s. Approximately how long will it take for both levels of the fountain to fill completely?

Exercise 2

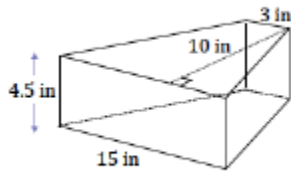

A decorative bathroom faucet has a 3 in. \times 3 in. square pipe that flows into a basin in the shape of an isosceles trapezoid prism like the one shown in the diagram. If it takes one minute and twenty seconds to fill the basin completely, what is the approximate rate of flow from the faucet in feet per second?

Summary



Lesson 26 - Independent Practice

1. Harvey puts a container in the shape of a right rectangular prism under a spot in the roof that is leaking. Rainwater is dripping into the container at an average rate of 12 drops a minute. The container Harvey places under the leak has a length and width of 5 cm and a height of 10 cm. Assuming each raindrop is roughly 1 cm^3 , approximately how long does Harvey have before the container overflows?

2. A large square pipe has inside dimensions $3 \text{ in.} \times 3 \text{ in.}$, and a small square pipe has inside dimensions $1 \text{ in.} \times 1 \text{ in.}$ Water travels through each of the pipes at the same constant speed. If the large pipe can fill a pool in 2 hours, how long will it take the small pipe to fill the same pool?

3. A pool contains $12,000 \text{ ft}^3$ of water and needs to be drained. At 8:00 a.m., a pump is turned on that drains water at the rate of 10 ft^3 per minute. Two hours later, at 10:00 a.m., a second pump is activated that drains water at the rate of 8 ft^3 per minute. At what time will the pool be empty?

Eureka Math Module 6 - Geometry

4. In the previous problem, if water starts flowing into the pool at noon at the rate of 3 ft^3 per minute, how much longer will it take to drain the pool?
5. A pool contains $6,000 \text{ ft}^3$ of water. Pump A can drain the pool in 15 hours, Pump B can drain it in 12 hours, and Pump C can drain it in 10 hours. How long will it take all three pumps working together to drain the pool?
6. A 2,000-gallon fish aquarium can be filled by water flowing at a constant rate in 10 hours. When a decorative rock is placed in the aquarium, it can be filled in 9.5 hours. Find the volume of the rock in cubic feet ($1 \text{ ft}^3 = 7.48 \text{ gal.}$).